



FİYAT LİSTESİ

*Fiyatlarımızdaki baskı ve dizgi aşamasında ortaya çıkabilecek sorunlarda "MERTİNOKS A.Ş." sorumlu değildir.
"MERTİNOKS A.Ş." fiyatlarda ve görsellerde her türlü değişiklik yapma hakkına sahiptir.*

iNDEX

YER SIFONLARI

04

DUŞ KANALLARI

29

DRENAJ KANALLARI

92

ENGELLİ SERİSİ

101

ÇÖP KOVALARI

107

WC FIRÇALIKLAR

131

DUŞ SETLERİ

135

AKSESUARLAR

138

İKON AÇIKLAMALARI



Yan Çıkış



File Montajlı



Alt Çıkış



Tekstil Membran Montajlı



İç Mekan



Bitüm Membran Montajlı



Dış Mekan



Düşük Yoğunluk Su Akışı



Sıcak - Soğuk Çalışma Ortamı



Yüksek Yoğunluk Su Akışı



Banyo (Islak Hacim)



Kilitli Sistem

YER SIFONLARI

EKO 10X10

Ürün Kodu	Kısa Kod	Çıkış	Ölçü	Fiyat	
YAN ÇIKIŞ					
3011.0Y050K.010.1	26583	Ø 50	10x10 cm	100	79.00

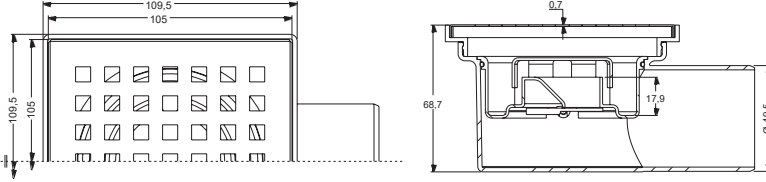

- Plastik gövde
- Paslanmaz ızgara
- Sulu koku tutucu

LINE 10x10

Ürün Kodu	Kısa Kod	Çıkış	Ölçü	Fiyat	
YAN ÇIKIŞ					
3012.0Y032K.010.1	13795	Ø 32	10x10 cm	160	90.00
3012.0Y040K.010.1	13800	Ø 40	10x10 cm	100	96.70
3012.0Y050K.010.1	13805	Ø 50	10x10 cm	100	96.70
3012.0Y070K.010.1	13812	Ø 70	10x10 cm	80	123.40
ALT ÇIKIŞ					
3012.0A040K.010.1	13818	Ø 40	10x10 cm	140	106.70
3012.0A050K.010.1	13826	Ø 50	10x10 cm	140	96.70
3012.0A070K.010.1	13832	Ø 70	10x10 cm	140	106.70
ELİTE LEGAL					
3012.0Y032K.010.B	28909	Ø 32	10x10 cm	40	170.00
3012.0Y050K.010.B	28910	Ø 50	10x10 cm	40	176.70

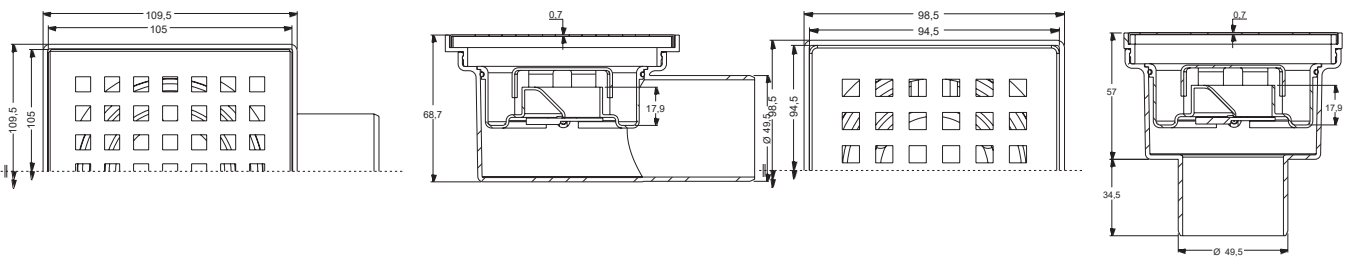

- Plastik gövde
- Paslanmaz ızgara
- Sulu koku tutucu
- Klepeli

Detaylar

DN 50 Yan ve Alt çıkış – Pvc boru bağlantılarına uyumludur. Akış hızı 32 lt/dk'dır. Iızgarası 304 kalite paslanmaz çeliktir.

Avantajlar

304 kalite paslanmaz çelik ızgarası sayesinde şık ve kaliteli bir görünüme sahiptir. Duvar dibi uygulamalarda rahatlıkla uygulanabilir. Su tutuculu koku önleyici sayesinde tesisattan gelecek kötü kokuları önler. Yükseltme ayakları sayesinde şapın yüksekliğine göre ayarlama olanağı sağlar. Organik ve inorganik kimyasallara yüksek dayanım. çoğu asidik ve tuzlu su oksidasyonuna dayanıklıdır.

Kullanım Alanları

Genel kullanım banyo duşları, hastane ve otel duş alanları, soyunma odaları duş alanları vb.

Özel Üretim

Iızgara modeli olarak isteğinize göre altın, bronz gibi renkler de üretilmektedir.

Uyarı

Yüksek yoğunluklu temizlik malzemelerinin uzun süreli kullanımı tavsiye edilmez.



KARE



ENDEKS

LINE 15x15



- Plastik gövde
- Paslanmaz ızgara
- Sulu koku tutucu
- Klepeli

Ürün Kodu	Kısa Kod	Çıkış	Ölçü	Fiyat	
YAN ÇIKIŞ					
3012.0Y032K.015.1	13882	Ø 32	15x15 cm	80	170.00
3012.0Y040K.015.1	13888	Ø 40	15x15 cm	60	180.00
3012.0Y050K.015.1	13896	Ø 50	15x15 cm	60	180.00
3012.0Y070K.015.1	13903	Ø 70	15x15 cm	50	206.70
ALT ÇIKIŞ					
3012.0A040K.015.1	13911	Ø 40	15x15 cm	60	190.00
3012.0A050K.015.1	13926	Ø 50	15x15 cm	60	180.00
3012.0A070K.015.1	13933	Ø 70	15x15 cm	60	190.00

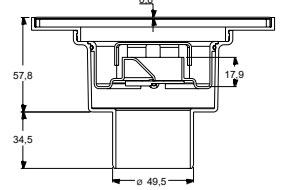
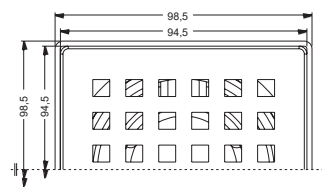
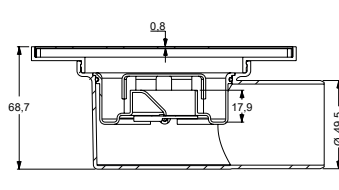
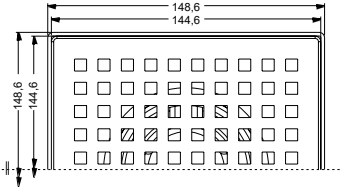

Detaylar

DN 50 Yan ve Alt çıkış – Pvc boru bağlantılarına uyumludur. Akış hızı 32 lt/dk'dır. Iızgarası 304 kalite paslanmaz çeliktir.

Avantajlar

304 kalite paslanmaz çelik ızgarası sayesinde şık ve kaliteli bir görünüme sahiptir. Duvar dibi uygulamalarda rahatlıkla uygulanabilir. Su tutuculu koku önleyici sayesinde tesisattan gelecek kötü kokuları önler. Yükseltme ayakları sayesinde şapın yüksekliğine göre ayarlama olanağı sağlar. Organik ve inorganik kimyasallara yüksek dayanım. çoğu asidik ve tuzlu su oksidasyonuna dayanıklıdır.

Kullanım Alanları

Genel kullanım banyo duşları, hastane ve otel duş alanları, soyunma odaları duş alanları vb.

Özel Üretim

Iızgara modeli olarak isteğinize göre altın, bronz gibi renkler de üretilmektedir.

Uyarı

Yüksek yoğunluklu temizlik malzemelerinin uzun süreli kullanımı tavsiye edilmez.



KARE



ENDEKS



- Plastik gövde
- Paslanmaz ızgara

KUCA

Ürün Kodu	Kısa Kod	Çıkış	Ölçü	Fiyat
ALT ÇIKIŞ				
5710.0A050K.010.1	13939	Ø 50	10x10 cm	133.40
5710.0A070K.010.1	13941	Ø 70	10x10 cm	136.00

SCALA 10x10

Ürün Kodu	Kısa Kod	Çıkış	Ölçü	Fiyat
YAN ÇIKIŞ				
3014.0Y032K.010.9	14005	Ø 32	10x10 cm	175.00
3014.0Y050K.010.9	14011	Ø 50	10x10 cm	181.00
ALT ÇIKIŞ				
3014.0A050K.010.9	14013	Ø 50	10x10 cm	180.00

- Plastik gövde
- Paslanmaz ızgara ve çerçeve
- Bariyerli koku tutucu

SCALA 15x15

Ürün Kodu	Kısa Kod	Çıkış	Ölçü	Fiyat
YAN ÇIKIŞ				
3014.0Y032K.015.9	14014	Ø 32	15x15 cm	243.40
3014.0Y050K.015.9	14015	Ø 50	15x15 cm	245.70
ALT ÇIKIŞ				
3014.0A050K.015.9	14017	Ø 50	15x15 cm	248.40

- Plastik gövde
- Paslanmaz ızgara
- Sulu klepeli koku tutucu

KÖŞE BALKON

Ürün Kodu	Kısa Kod	Çıkış	Fiyat
Ø70			
6001.0A070.13.0	13942	Ø 70	153.40
Ø100			
6002.0A100.16.0	13945	Ø 100	173.40

- Plastik gövde

MIDI 10X10

Ürün Kodu	Kısa Kod	Çıkış	Ölçü		Fiyat
YAN ÇIKIŞ					
5001.0Y032.010.1	14010	Ø 32	10x10 cm	80	153.40
5001.0Y040.010.1	14018	Ø 40	10x10 cm	60	160.00
5001.0Y050.010.1	14022	Ø 50	10x10 cm	60	160.00
5001.0Y070.010.1	14025	Ø 70	10x10 cm	40	193.40
ALT ÇIKIŞ					
5001.0A040.010.1	14032	Ø 40	10x10 cm	50	176.70
5001.0A050.010.1	14035	Ø 50	10x10 cm	50	166.70
5001.0A070.010.1	14039	Ø 70	10x10 cm	50	176.70



- Plastik gövde
- Paslanmaz ızgara
- Sulu koku tutucu
- Klepeli

STD. 10x10

Ürün Kodu	Kısa Kod	Çıkış	Ölçü		Fiyat
YAN ÇIKIŞ					
5002.0Y032.010.1	14019	Ø 32	10x10 cm	60	216.00
5002.0Y040.010.1	14041	Ø 40	10x10 cm	50	219.40
5002.0Y050.010.1	14046	Ø 50	10x10 cm	50	212.70
5002.0Y070.010.1	14050	Ø 70	10x10 cm	40	235.70
5002.0Y100.010.1	14052	Ø 100	10x10 cm	20	282.40
ALT ÇIKIŞ					
5002.0A040.010.1	14062	Ø 40	10x10 cm	50	214.70
5002.0A050.010.1	14067	Ø 50	10x10 cm	50	215.70
5002.0A070.010.1	14078	Ø 70	10x10 cm	40	221.00
5002.0A100.010.1	14083	Ø 100	10x10 cm	40	221.70
S SIFONLU					
5012.0Y050.010.1	34283	Ø 50	10x10 cm	40	375.00
İKİ ÇIKIŞLI					
5022.0Y050.010.1	34284	Ø 50	10x10 cm	18	347.40
5022.0Y070.010.1	34285	Ø 70	10x10 cm	18	347.40
DÖRT ÇIKIŞLI					
5042.0Y050.010.1	34286	Ø 50	10x10 cm	18	354.00
5042.0Y070.010.1	34287	Ø 70	10x10 cm	18	354.00



• Yan Çıkış

• Alt Çıkış

• S Sifon

• İkili Çıkış

• Dörtlü Çıkış

- Plastik gövde
- Paslanmaz ızgara
- Sulu koku tutucu
- Klepeli

STD. FİLELİ 10X10



Ürün Kodu	Kısa Kod	Çıkış	Ölçü	Fiyat
YAN ÇIKIŞ				
5002.FY032.010.1	14059	Ø 32	10x10 cm	237.40
5002.FY040.010.1	14055	Ø 40	10x10 cm	241.40
5002.FY050.010.1	14061	Ø 50	10x10 cm	235.00
5002.FY070.010.1	14068	Ø 70	10x10 cm	258.00
5002.FY100.010.1	14073	Ø 100	10x10 cm	305.00
ALT ÇIKIŞ				
5002.FA040.010.1	14077	Ø 40	10x10 cm	236.70
5002.FA050.010.1	14084	Ø 50	10x10 cm	238.00
5002.FA070.010.1	14088	Ø 70	10x10 cm	243.40
5002.FA100.010.1	14093	Ø 100	10x10 cm	244.00
S SIFONLU				
5012.FY050.010.1	34288	Ø 50	10x10 cm	397.00
İKİ ÇIKIŞLI				
5022.FY050.010.1	34289	Ø 50	10x10 cm	370.00
5022.FY070.010.1	34290	Ø 70	10x10 cm	370.00
DÖRT ÇIKIŞLI				
5042.FY050.010.1	34291	Ø 50	10x10 cm	376.70
5042.FY070.010.1	34292	Ø 70	10x10 cm	376.70

- Plastik gövde
- Paslanmaz ızgara
- Fileli
- Sulu klepeli koku tutucu

STD. T. MEMBRANLI 10X10

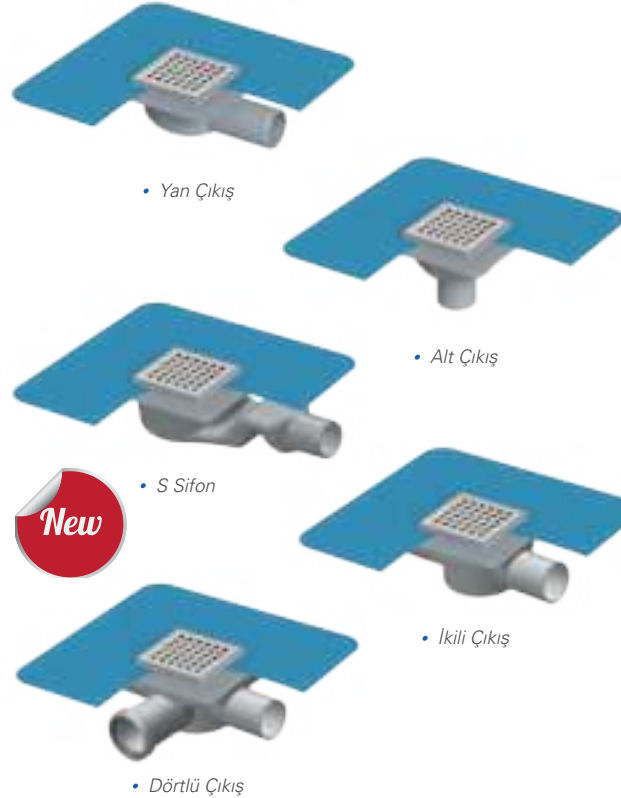

Ürün Kodu	Kısa Kod	Çıkış	Ölçü	Fiyat
YAN ÇIKIŞ				
5002.TY032.010.1	14091	Ø 32	10x10 cm	252.70
5002.TY040.010.1	14103	Ø 40	10x10 cm	256.70
5002.TY050.010.1	14107	Ø 50	10x10 cm	250.00
5002.TY070.010.1	14112	Ø 70	10x10 cm	274.00
5002.TY100.010.1	14120	Ø 100	10x10 cm	322.70
ALT ÇIKIŞ				
5002.TA040.010.1	14124	Ø 40	10x10 cm	252.00
5002.TA050.010.1	14128	Ø 50	10x10 cm	253.00
5002.TA070.010.1	14132	Ø 70	10x10 cm	258.70
5002.TA100.010.1	14136	Ø 100	10x10 cm	259.40
S SIFONLU				
5012.TY050.010.1	34293	Ø 50	10x10 cm	418.40
İKİ ÇIKIŞLI				
5022.TY050.010.1	34294	Ø 50	10x10 cm	390.00
5022.TY070.010.1	34295	Ø 70	10x10 cm	390.00
DÖRT ÇIKIŞLI				
5042.TY050.010.1	34296	Ø 50	10x10 cm	396.70
5042.TY070.010.1	34297	Ø 70	10x10 cm	396.70

- Plastik gövde
- Paslanmaz ızgara
- Tekstil membranlı
- Sulu klepeli koku tutucu



PASLANMAZ YER SIFONLARI

MAXIFLOW
Maksimum akış...

BEBCO 10x10

Ürün Kodu	Kısa Kod	Ölçü	Fiyat
ALT ÇIKIŞ			
3166.1010P1.100.0	34892	10x10 cm	206.70

New



BEBCO 15x15

Ürün Kodu	Kısa Kod	Ölçü	Fiyat
ALT ÇIKIŞ			
3166.1515P1.100.0	34893	15x15 cm	300.00

New



LİBRA 10x10

Ürün Kodu	Kısa Kod	Ölçü	Fiyat
ALT ÇIKIŞ			
3074.0A050P010.1	34894	10x10 cm	470.00

New



LİBRA 15x15

Ürün Kodu	Kısa Kod	Ölçü	Fiyat
ALT ÇIKIŞ			
3074.0A050P015.1	34895	15x15 cm	663.40

New



PREMIUM 10x10



Ürün Kodu	Kısa Kod	Çıkış	Ölçü		Fiyat
YAN ÇIKIŞ					
3045.0Y032K.010.1	14096	Ø 32	10x10 cm	24	553.40
3045.0Y050K.010.1	14097	Ø 50	10x10 cm	24	593.40
ALT ÇIKIŞ					
3045.0A050K.010.1	14099	Ø 50	10x10 cm	24	566.70

- Paslanmaz gövde
- Paslanmaz ızgara
- Paslanmaz koku tutucu

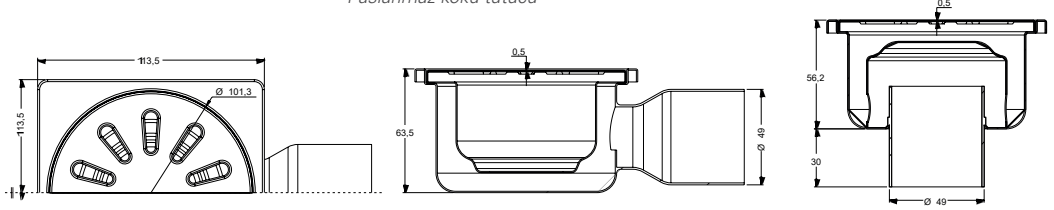

PREMIUM 15X15



Ürün Kodu	Kısa Kod	Çıkış	Ölçü		Fiyat
YAN ÇIKIŞ					
3045.0Y032K.015.1	14100	Ø 32	15x15 cm	24	603.40
3045.0Y050K.015.1	14102	Ø 50	15x15 cm	24	646.70
3045.0Y070K.015.1	14104	Ø 70	15x15 cm	24	686.70
ALT ÇIKIŞ					
3045.0A050K.015.1	14108	Ø 50	15x15 cm	24	620.00
3045.0A070K.015.1	14111	Ø 70	15x15 cm	24	696.70

- Paslanmaz gövde
- Paslanmaz ızgara
- Paslanmaz koku tutucu

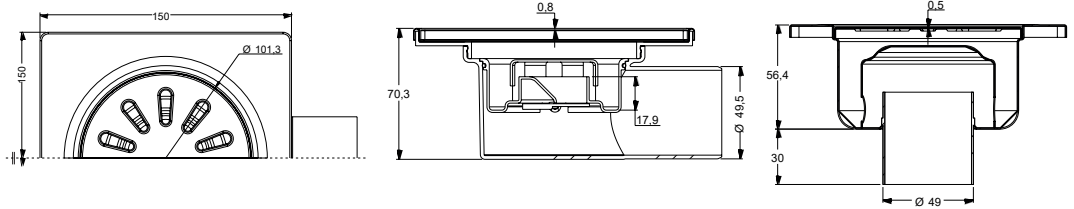

PREMIUM 20x20



Ürün Kodu	Kısa Kod	Çıkış	Ölçü		Fiyat
YAN ÇIKIŞ					
3045.0Y070K.020.1	14115	Ø 70	20x20 cm	12	2490.00
3045.0Y100K.020.1	14116	Ø 100	20x20 cm	12	2666.70
ALT ÇIKIŞ					
3045.0A070K.020.1	14117	Ø 70	20x20 cm	12	2466.70
3045.0A100K.020.1	14119	Ø 100	20x20 cm	12	2680.00

- Paslanmaz gövde
- Paslanmaz ızgara
- Paslanmaz koku tutucu

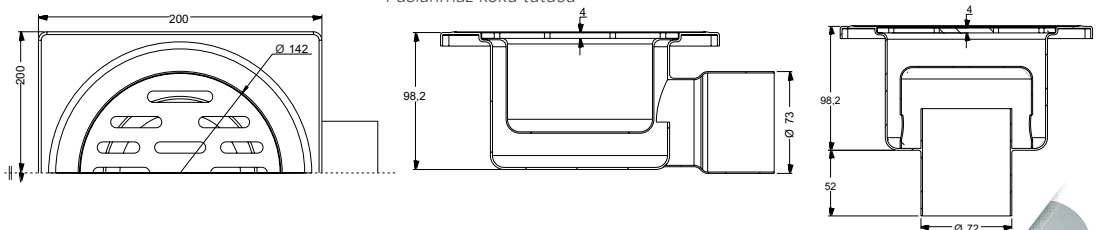

SIFON ÜST GÖVDE

LINE

Ürün Kodu	Kısa Kod	Çıkış	Ölçü	Fiyat
10X10				
5101.0A100.10.1	14198	Ø 100	10x10 cm	156.70
15X15				
5107.0A100.15.1	14200	Ø 100	15x15 cm	256.70

- Plastik gövde
- Paslanmaz ızgara
- Sulu klepelî koku tutucu



LEGAL

Ürün Kodu	Kısa Kod	Çıkış	Ölçü	Fiyat
10X10				
5102.0A100.10.1	14204	Ø 100	10x10 cm	220.00
15X15				
5108.0A100.15.1	14206	Ø 100	15x15 cm	340.00

- Plastik gövde
- Paslanmaz ızgara
- Sulu klepelî koku tutucu



PREMIUM

Ürün Kodu	Kısa Kod	Çıkış	Ölçü	Fiyat
10X10				
5105.0A100.10.0	14207	Ø 100	10x10 cm	263.40
15X15				
5111.0A100.15.0	14209	Ø 100	15x15 cm	316.70

- Plastik gövde
- Paslanmaz ızgara
- Sulu klepelî koku tutucu



RING

Ürün Kodu	Kısa Kod	Çıkış	Fiyat
RING			
1207001100100	14208	Ø 100	56.70
IZGARALI RING			
5112.0A100.00.1	14210	Ø 100	170.00

• Yükseltme ara parçası



- Plastik gövde
- Paslanmaz ızgara
- Sulu klepelî koku tutucu



KARE



ENDEKS



SCALA

Ürün Kodu	Kısa Kod	Çıkış	Ölçü		Fiyat
10X10					
5103.0A100.10.0	14199	Ø 100	10x10 cm	120	120.00
15X15					
5109.0A100.15.0	14202	Ø 100	15x15 cm	80	163.40

- Plastik gövde
- Sulu klepeli koku tutucu



ELİT

Ürün Kodu	Kısa Kod	Çıkış	Ölçü		Fiyat
10X10					
5104.0A100.10.0	14203	Ø 100	10x10 cm	120	280.00
15X15					
5110.0A100.15.0	14205	Ø 100	15x15 cm	80	343.40

- Plastik gövde
- Paslanmaz ızgara
- Sulu klepeli koku tutucu



DELUXE

Ürün Kodu	Kısa Kod	Çıkış	Ölçü		Fiyat
10X10 1.5 mm					
5113.0A100.10.0	34896	Ø 100	10x10 cm	120	296.70
15X15 2 mm					
5113.0A100.15.0	34897	Ø 100	15x15 cm	80	523.40

- Plastik gövde
- Paslanmaz ızgara
- Sulu klepeli koku tutucu



DELUXE

Ürün Kodu	Kısa Kod	Çıkış	Ölçü		Fiyat
10X10 2 mm					
5114.0A100.10.0	34898	Ø 100	10x10 cm	120	323.40
15X15 3 mm					
5114.0A100.15.0	34899	Ø 100	15x15 cm	80	660.00

- Plastik gövde
- Paslanmaz ızgara
- Sulu klepeli koku tutucu

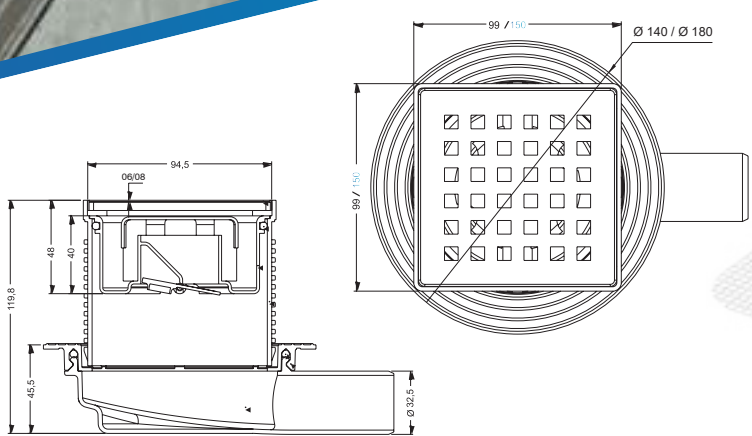

Ø 32 YAN ÇIKIŞ

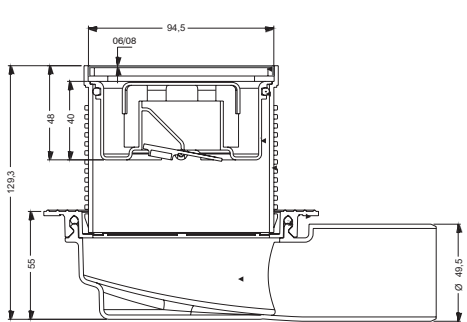

Ø 50 YAN ÇIKIŞ

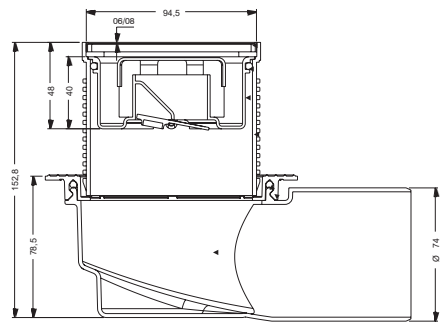

Ø 70 YAN ÇIKIŞ

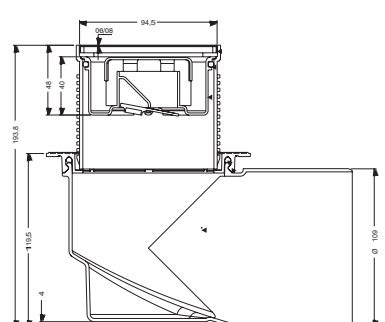

Ø 100 YAN ÇIKIŞ

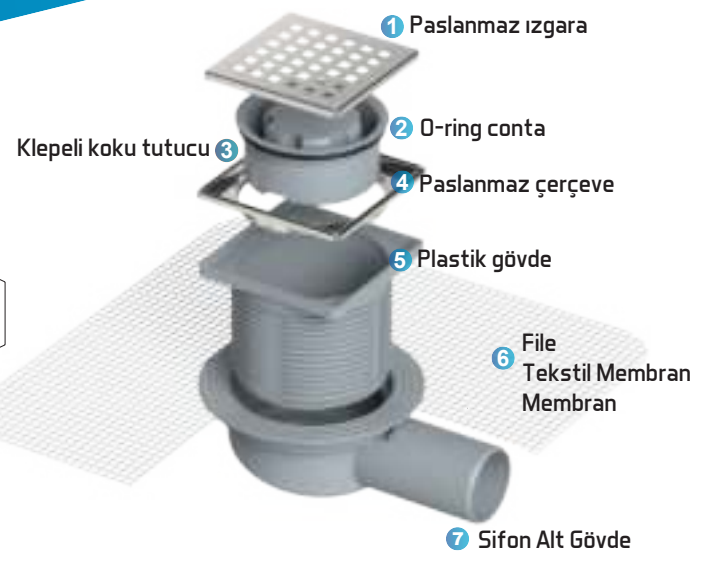

SİFON ALT GÖVDE



New

S SİFON 140 MM DUVAR DİBİ

Ürün Kodu	Kısa Kod	Çıkış		Fiyat
5114.OY050.00.0	34298	Ø 50	70	260.00



New

S SİFON 180 MM

Ürün Kodu	Kısa Kod	Çıkış		Fiyat
5118.OY050.00.0	34299	Ø 50	65	270.00

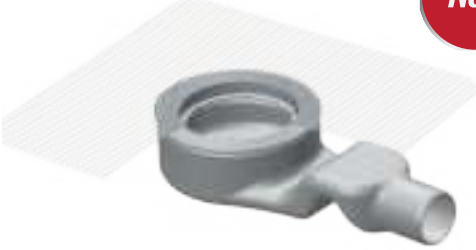

New

S SİFON 140 MM FİLELİ

Ürün Kodu	Kısa Kod	Çıkış		Fiyat
5114.FY050.00.0	34300	Ø 50	70	280.00



New

S SİFON 180 MM FİLELİ

Ürün Kodu	Kısa Kod	Çıkış		Fiyat
5118.FY050.00.0	34301	Ø 50	65	290.00

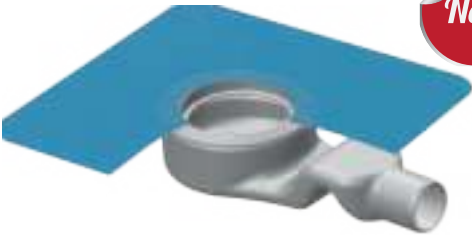

New

S SİFON 140 MM T. MEMBRANLI

Ürün Kodu	Kısa Kod	Çıkış		Fiyat
5114.TY050.00.0	34302	Ø 50	70	296.70

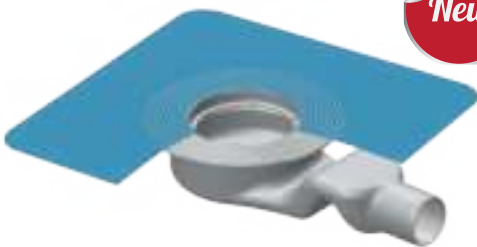

New

S SİFON 180 MM T. MEMBRANLI

Ürün Kodu	Kısa Kod	Çıkış		Fiyat
5118.TY050.00.0	34303	Ø 50	65	306.70

SIFON ALT GÖVDE

İKİ ÇIKIŞLI 140 MM DUVAR DİBİ

Ürün Kodu	Kısa Kod	Çıkış		Fiyat
5214.OY050.00.0	34304	Ø 50	30	226.70
5214.OY070.00.0	34305	Ø 70	30	226.70

New



İKİ ÇIKIŞLI 180 MM

Ürün Kodu	Kısa Kod	Çıkış		Fiyat
5218.OY050.00.0	34306	Ø 50	30	236.70
5218.OY070.00.0	34307	Ø 70	30	236.70

New



İKİ ÇIKIŞLI 140 MM FİLELİ

Ürün Kodu	Kısa Kod	Çıkış		Fiyat
5214.FY050.00.0	34308	Ø 50	30	250.00
5214.FY070.00.0	34309	Ø 70	30	250.00

New



İKİ ÇIKIŞLI 180 MM FİLELİ

Ürün Kodu	Kısa Kod	Çıkış		Fiyat
5218.FY050.00.0	34310	Ø 50	30	256.70
5218.FY070.00.0	34311	Ø 70	30	256.70

New



İKİ ÇIKIŞLI 140 MM T. MEMBRANLI

Ürün Kodu	Kısa Kod	Çıkış		Fiyat
5214.TY050.00.0	34312	Ø 50	30	266.70
5214.TY070.00.0	34313	Ø 70	30	266.70

New



İKİ ÇIKIŞLI 180 MM T. MEMBRANLI

Ürün Kodu	Kısa Kod	Çıkış		Fiyat
5218.TY050.00.0	34314	Ø 50	30	273.40
5218.TY070.00.0	34315	Ø 70	30	273.40

New

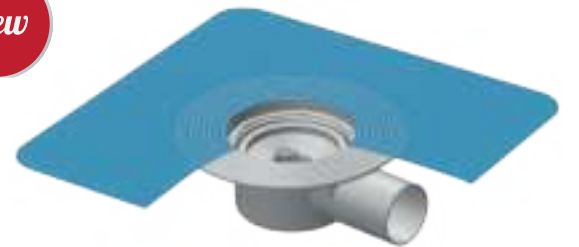



New

DÖRT ÇIKIŞLI 140 MM DUVAR DİBİ

Ürün Kodu	Kısa Kod	Çıkış		Fiyat
5414.OY050.00.0	34316	Ø 50	30	233.40
5414.OY070.00.0	34317	Ø 70	30	233.40



New

DÖRT ÇIKIŞLI 180 MM

Ürün Kodu	Kısa Kod	Çıkış		Fiyat
5418.OY050.00.0	34318	Ø 50	30	243.40
5418.OY070.00.0	34319	Ø 70	30	243.40



New

DÖRT ÇIKIŞLI 140 MM FİLELİ

Ürün Kodu	Kısa Kod	Çıkış		Fiyat
5414.FY050.00.0	34320	Ø 50	30	256.70
5414.FY070.00.0	34321	Ø 70	30	256.70



New

DÖRT ÇIKIŞLI 180 MM FİLELİ

Ürün Kodu	Kısa Kod	Çıkış		Fiyat
5418.FY050.00.0	34322	Ø 50	30	263.40
5418.FY070.00.0	34323	Ø 70	30	263.40

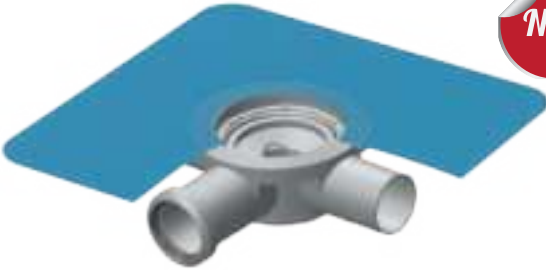

New

DÖRT ÇIKIŞLI 140 MM T. MEMBRANLI

Ürün Kodu	Kısa Kod	Çıkış		Fiyat
5414.TY050.00.0	34324	Ø 50	30	273.40
5414.TY070.00.0	34325	Ø 70	30	273.40



New

DÖRT ÇIKIŞLI 180 MM T. MEMBRANLI

Ürün Kodu	Kısa Kod	Çıkış		Fiyat
5418.TY050.00.0	34326	Ø 50	30	280.00
5418.TY070.00.0	34327	Ø 70	30	280.00

SIFON ALT GÖVDE

140MM DUVAR DİBİ

Ürün Kodu	Kısa Kod	Çıkış	Yükseklik		Fiyat
YAN ÇIKIŞ					
5014.0Y032.00.0	14212	Ø 32	46 mm	125	93.40
5014.0Y040.00.0	14213	Ø 40	55 mm	125	93.40
5014.0Y050.00.0	14215	Ø 50	55 mm	100	96.70
5014.0Y070.00.0	14224	Ø 70	79 mm	75	113.40
5014.0Y100.00.0	14225	Ø 100	115 mm	48	146.70
ALT ÇIKIŞ					
5014.0A040.00.0	14226	Ø 40	96 mm	140	90.00
5014.0A050.00.0	14227	Ø 50	96 mm	140	90.00
5014.0A070.00.0	14228	Ø 70	96 mm	100	93.40
5014.0A100.00.0	14229	Ø 100	96 mm	72	100.00

- Sifon alt gövde
- 140 mm flanşlı



180MM

Ürün Kodu	Kısa Kod	Çıkış	Yükseklik		Fiyat
YAN ÇIKIŞ					
5018.0Y032.00.0	14211	Ø 32	46 mm	100	106.70
5018.0Y040.00.0	14214	Ø 40	55 mm	100	106.70
5018.0Y050.00.0	14216	Ø 50	55 mm	100	106.70
5018.0Y070.00.0	14217	Ø 70	79 mm	75	120.00
5018.0Y100.00.0	14218	Ø 100	115 mm	35	166.70
ALT ÇIKIŞ					
5018.0A040.00.0	14219	Ø 40	96 mm	100	100.00
5018.0A050.00.0	14220	Ø 50	96 mm	100	100.00
5018.0A070.00.0	14221	Ø 70	96 mm	85	103.40
5018.0A100.00.0	14222	Ø 100	96 mm	60	113.40

- Sifon alt gövde
- 180 mm flanşlı



210MM

Ürün Kodu	Kısa Kod	Çıkış	Yükseklik		Fiyat
YAN ÇIKIŞ					
5021.0Y032.00.0	14231	Ø 32	46 mm	100	126.70
5021.0Y040.00.0	14232	Ø 40	55 mm	100	126.70
5021.0Y050.00.0	14233	Ø 50	55 mm	100	126.70
5021.0Y070.00.0	14234	Ø 70	79 mm	70	143.40
5021.0Y100.00.0	14236	Ø 100	115 mm	30	193.40
ALT ÇIKIŞ					
5021.0A040.00.0	14237	Ø 40	96 mm	100	123.40
5021.0A050.00.0	14239	Ø 50	96 mm	100	123.40
5021.0A070.00.0	14241	Ø 70	96 mm	60	133.40
5021.0A100.00.0	14243	Ø 100	96 mm	40	146.70

- Sifon alt gövde
- 210 mm flanşlı



140 MM FİLELİ

Ürün Kodu	Kısa Kod	Çıkış	Yükseklik		Fiyat
YAN ÇIKIŞ					
5014.FY032.00.0	14230	Ø 32	46 mm	100	123.40
5014.FY040.00.0	14235	Ø 40	55 mm	100	123.40
5014.FY050.00.0	14238	Ø 50	55 mm	100	123.40
5014.FY070.00.0	14242	Ø 70	79 mm	75	140.00
5014.FY100.00.0	14244	Ø 100	115 mm	48	173.40
ALT ÇIKIŞ					
5014.FA040.00.0	14246	Ø 40	96 mm	100	120.00
5014.FA050.00.0	14247	Ø 50	96 mm	100	120.00
5014.FA070.00.0	14248	Ø 70	96 mm	75	123.40
5014.FA100.00.0	14249	Ø 100	96 mm	72	126.70

- Sifon alt gövde
- 140 mm fileli flanşlı

180MM FİLELİ

Ürün Kodu	Kısa Kod	Çıkış	Yükseklik		Fiyat
YAN ÇIKIŞ					
5018.FY032.00.0	14245	Ø 32	46 mm	100	133.40
5018.FY040.00.0	14250	Ø 40	55 mm	100	133.40
5018.FY050.00.0	14251	Ø 50	55 mm	100	133.40
5018.FY070.00.0	14253	Ø 70	79 mm	75	146.70
5018.FY100.00.0	14255	Ø 100	115 mm	35	193.40
ALT ÇIKIŞ					
5018.FA040.00.0	14262	Ø 40	96 mm	100	126.70
5018.FA050.00.0	14265	Ø 50	96 mm	100	130.00
5018.FA070.00.0	14266	Ø 70	96 mm	85	130.00
5018.FA100.00.0	14267	Ø 100	96 mm	60	140.00

- Sifon alt gövde
- 180 mm fileli flanşlı

140MM T. MEMBRANLI

Ürün Kodu	Kısa Kod	Çıkış	Yükseklik		Fiyat
YAN ÇIKIŞ					
5014.TY032.00.0	14252	Ø 32	46 mm	100	136.70
5014.TY040.00.0	14254	Ø 40	55 mm	100	136.70
5014.TY050.00.0	14256	Ø 50	55 mm	100	140.00
5014.TY070.00.0	14257	Ø 70	79 mm	75	156.70
5014.TY100.00.0	14258	Ø 100	115 mm	48	193.40
ALT ÇIKIŞ					
5014.TA040.00.0	14259	Ø 40	96 mm	100	133.40
5014.TA050.00.0	14260	Ø 50	96 mm	100	133.40
5014.TA070.00.0	14261	Ø 70	96 mm	75	140.00
5014.TA100.00.0	14263	Ø 100	96 mm	72	143.40

- Sifon alt gövde
- 140 mm Tekstil Membranlı flanşlı

SIFON ALT GÖVDE

180 MM T.MEMBRANLI

Ürün Kodu	Kısa Kod	Çıkış	Yükseklik		Fiyat
YAN ÇIKIŞ					
5018.TY032.00.0	14264	Ø 32	46 mm	100	146.70
5018.TY040.00.0	14268	Ø 40	55 mm	100	146.70
5018.TY050.00.0	14270	Ø 50	55 mm	100	146.70
5018.TY070.00.0	14271	Ø 70	79 mm	75	166.70
5018.TY100.00.0	14272	Ø 100	115 mm	35	213.40
ALT ÇIKIŞ					
5018.TA040.00.0	14273	Ø 40	96 mm	100	143.40
5018.TA050.00.0	14276	Ø 50	96 mm	100	143.40
5018.TA070.00.0	14278	Ø 70	96 mm	85	146.70
5018.TA100.00.0	14280	Ø 100	96 mm	60	156.70

- Sifon alt gövde
- 180 mm tekstil membranlı flanşlı

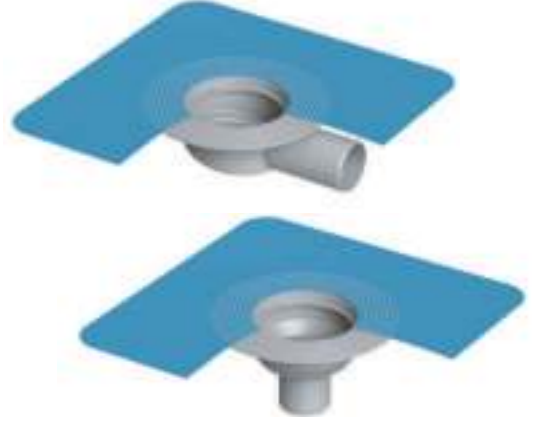

210 MM MEMBRANLI

Ürün Kodu	Kısa Kod	Çıkış	Yükseklik		Fiyat
YAN ÇIKIŞ					
5021.MY032.00.0	14269	Ø 32	50 mm	40	290.00
5021.MY040.00.0	14274	Ø 40	59 mm	40	290.00
5021.MY050.00.0	14277	Ø 50	59 mm	40	290.00
5021.MY070.00.0	14279	Ø 70	84 mm	30	313.40
5021.MY100.00.0	14281	Ø 100	119 mm	30	333.40
ALT ÇIKIŞ					
5021.MA040.00.0	14283	Ø 40	100 mm	35	290.00
5021.MA050.00.0	14284	Ø 50	100 mm	35	290.00
5021.MA070.00.0	14285	Ø 70	100 mm	30	296.70
5021.MA100.00.0	14287	Ø 100	100 mm	30	300.00

- Paslanmaz gövde
- Paslanmaz flanş takımı
- Bitüm membranlı



ALT ÇIKIŞ ÖLÇÜLERİ

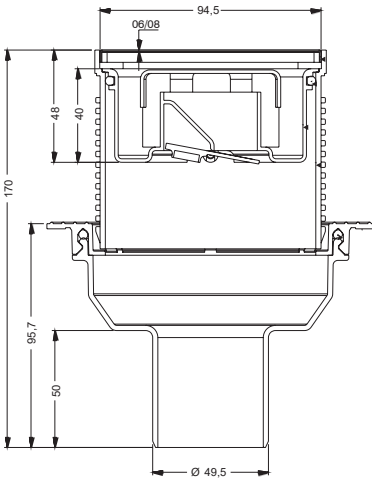

Ø 50 ALT ÇIKIŞ

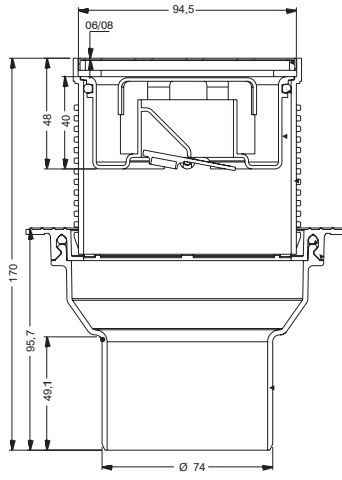

Ø 70 ALT ÇIKIŞ

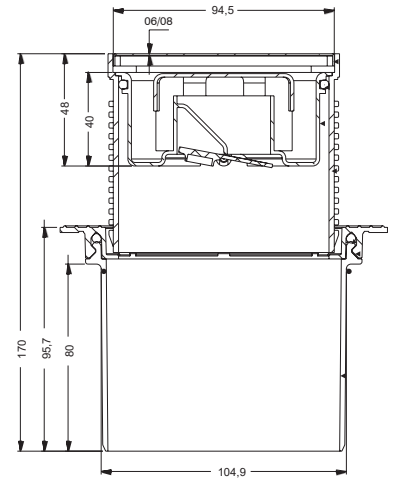

Ø 100 ALT ÇIKIŞ

140 MM 10x10 DUVAR DİBİ



• Yan Çıkış



• Alt Çıkış



• S Sifon



• İkili Çıkış



• Dörtlü Çıkış



Ürün Kodu	Kısa Kod	Çıkış	Ölçü	Fiyat
YAN ÇIKIŞ				
5054.0Y032.10.1	14282	Ø 32	10x10 cm 50	280.00
5054.0Y040.10.1	14286	Ø 40	10x10 cm 50	280.00
5054.0Y050.10.1	14289	Ø 50	10x10 cm 50	280.00
5054.0Y070.10.1	14290	Ø 70	10x10 cm 50	293.40
5054.0Y100.10.1	14291	Ø 100	10x10 cm 30	333.40
ALT ÇIKIŞ				
5054.0A040.10.1	14292	Ø 40	10x10 cm 50	276.70
5054.0A050.10.1	14293	Ø 50	10x10 cm 50	276.70
5054.0A070.10.1	14294	Ø 70	10x10 cm 50	276.70
5054.0A100.10.1	14295	Ø 100	10x10 cm 40	286.70
S SIFONLU				
5154.0Y050.10.1	34328	Ø 50	10x10 cm 40	443.40
İKİ ÇIKIŞLI				
5254.0Y050.10.1	34329	Ø 50	10x10 cm 20	436.70
5254.0Y070.10.1	34330	Ø 70	10x10 cm 20	436.70
DÖRT ÇIKIŞLI				
5454.0Y050.10.1	34331	Ø 50	10x10 cm 20	443.40
5454.0Y070.10.1	34332	Ø 70	10x10 cm 20	443.40

- Plastik gövde
- Paslanmaz ızgara
- Sulu klepelili koku tutucu
- 140 mm flanşlı

180MM 10X10



• Yan Çıkış



• Alt Çıkış



• S Sifon



• İkili Çıkış



• Dörtlü Çıkış



Ürün Kodu	Kısa Kod	Çıkış	Ölçü	Fiyat
YAN ÇIKIŞ				
5058.0Y032.10.1	14288	Ø 32	10x10 cm 50	290.00
5058.0Y040.10.1	14296	Ø 40	10x10 cm 50	290.00
5058.0Y050.10.1	14299	Ø 50	10x10 cm 50	290.00
5058.0Y070.10.1	14302	Ø 70	10x10 cm 40	306.70
5058.0Y100.10.1	14303	Ø 100	10x10 cm 30	340.00
ALT ÇIKIŞ				
5058.0A040.10.1	14305	Ø 40	10x10 cm 50	283.40
5058.0A050.10.1	14307	Ø 50	10x10 cm 50	283.40
5058.0A070.10.1	14309	Ø 70	10x10 cm 40	293.40
5058.0A100.10.1	14311	Ø 100	10x10 cm 30	306.70
S SIFONLU				
5158.0Y050.10.1	34333	Ø 50	10x10 cm 40	450.00
İKİ ÇIKIŞLI				
5258.0Y050.10.1	34334	Ø 50	10x10 cm 20	430.00
5258.0Y070.10.1	34335	Ø 70	10x10 cm 20	430.00
DÖRT ÇIKIŞLI				
5458.0Y050.10.1	34336	Ø 50	10x10 cm 20	436.70
5458.0Y070.10.1	34337	Ø 70	10x10 cm 20	436.70

- Plastik gövde
- Paslanmaz ızgara
- Sulu klepelili koku tutucu
- 180 mm flanşlı

140 MM 10x10 FİLELİ

Ürün Kodu	Kısa Kod	Çıkış	Ölçü	Fiyat	
YAN ÇIKIŞ					
5054.FY032.10.1	14313	Ø 32	10x10 cm	50	303.40
5054.FY040.10.1	14319	Ø 40	10x10 cm	50	303.40
5054.FY050.10.1	14321	Ø 50	10x10 cm	50	303.40
5054.FY070.10.1	14322	Ø 70	10x10 cm	50	313.40
5054.FY100.10.1	14323	Ø 100	10x10 cm	30	353.40
ALT ÇIKIŞ					
5054.FA040.10.1	14324	Ø 40	10x10 cm	50	296.70
5054.FA050.10.1	14325	Ø 50	10x10 cm	50	296.70
5054.FA070.10.1	14326	Ø 70	10x10 cm	50	296.70
5054.FA100.10.1	14327	Ø 100	10x10 cm	40	306.70
S SIFONLU					
5154.FY050.10.1	34338	Ø 50	10x10 cm	40	463.40
İKİ ÇIKIŞLI					
5254.FY050.10.1	34339	Ø 50	10x10 cm	20	443.40
5254.FY070.10.1	34340	Ø 70	10x10 cm	20	443.40
DÖRT ÇIKIŞLI					
5454.FY050.10.1	34341	Ø 50	10x10 cm	20	450.00
5454.FY070.10.1	34342	Ø 70	10x10 cm	20	450.00

- Plastik gövde
- Paslanmaz ızgara
- Sulu klepeli koku tutucu
- 140 mm fileli flanşlı

180 MM 10x10 FİLELİ

Ürün Kodu	Kısa Kod	Çıkış	Ölçü	Fiyat	
YAN ÇIKIŞ					
5058.FY032.10.1	14315	Ø 32	10x10 cm	50	310.00
5058.FY040.10.1	14316	Ø 40	10x10 cm	50	310.00
5058.FY050.10.1	14317	Ø 50	10x10 cm	50	310.00
5058.FY070.10.1	14318	Ø 70	10x10 cm	40	330.00
5058.FY100.10.1	14320	Ø 100	10x10 cm	30	360.00
ALT ÇIKIŞ					
5058.FA040.10.1	14328	Ø 40	10x10 cm	50	306.70
5058.FA050.10.1	14330	Ø 50	10x10 cm	50	306.70
5058.FA070.10.1	14331	Ø 70	10x10 cm	40	313.40
5058.FA100.10.1	14332	Ø 100	10x10 cm	30	326.70
S SIFONLU					
5158.FY050.10.1	34343	Ø 50	10x10 cm	40	473.40
İKİ ÇIKIŞLI					
5258.FY050.10.1	34344	Ø 50	10x10 cm	20	450.00
5258.FY070.10.1	34345	Ø 70	10x10 cm	20	450.00
DÖRT ÇIKIŞLI					
5458.FY050.10.1	34346	Ø 50	10x10 cm	20	456.70
5458.FY070.10.1	34347	Ø 70	10x10 cm	20	456.70

- Plastik gövde
- Paslanmaz ızgara
- Sulu klepeli koku tutucu
- 180 mm fileli flanşlı



180MM 15X15

Ürün Kodu	Kısa Kod	Çıkış	Ölçü	Fiyat
YAN ÇIKIŞ				
5058.0Y032.15.1	14298	Ø 32	15x15cm	373.40
5058.0Y040.15.1	14300	Ø 40	15x15cm	373.40
5058.0Y050.15.1	14301	Ø 50	15x15cm	373.40
5058.0Y070.15.1	14304	Ø 70	15x15cm	403.40
5058.0Y100.15.1	14306	Ø 100	15x15cm	450.00
ALT ÇIKIŞ				
5058.0A040.15.1	14308	Ø 40	15x15cm	370.00
5058.0A050.15.1	14310	Ø 50	15x15cm	370.00
5058.0A070.15.1	14312	Ø 70	15x15cm	376.70
5058.0A100.15.1	14314	Ø 100	15x15cm	390.00
S SIFONLU				
5158.0Y050.15.1	34348	Ø 50	15x15cm	550.00
İKİ ÇIKIŞLI				
5258.0Y050.15.1	34349	Ø 50	15x15cm	513.40
5258.0Y070.15.1	34350	Ø 70	15x15cm	513.40
DÖRT ÇIKIŞLI				
5458.0Y050.15.1	34351	Ø 50	15x15cm	520.00
5458.0Y070.15.1	34352	Ø 70	15x15cm	520.00

- Plastik gövde
- Paslanmaz ızgara
- Sulu klepelili koku tutucu
- 180 mm flanşlı

180 MM 15x15 FİLELİ

Ürün Kodu	Kısa Kod	Çıkış	Ölçü	Fiyat
YAN ÇIKIŞ				
5058.FY032.15.1	14333	Ø 32	15x15cm	393.40
5058.FY040.15.1	14334	Ø 40	15x15cm	393.40
5058.FY050.15.1	14335	Ø 50	15x15cm	393.40
5058.FY070.15.1	14336	Ø 70	15x15cm	426.70
5058.FY100.15.1	14337	Ø 100	15x15cm	473.40
ALT ÇIKIŞ				
5058.FA040.15.1	14338	Ø 40	15x15cm	390.00
5058.FA050.15.1	14340	Ø 50	15x15cm	390.00
5058.FA070.15.1	14341	Ø 70	15x15cm	400.00
5058.FA100.15.1	14344	Ø 100	15x15cm	413.40
S SIFONLU				
5158.FY050.15.1	34353	Ø 50	15x15cm	570.00
İKİ ÇIKIŞLI				
5258.FY050.15.1	34354	Ø 50	15x15cm	536.70
5258.FY070.15.1	34355	Ø 70	15x15cm	536.70
DÖRT ÇIKIŞLI				
5458.FY050.15.1	34356	Ø 50	15x15cm	543.40
5458.FY070.15.1	34357	Ø 70	15x15cm	543.40

- Plastik gövde
- Paslanmaz ızgara
- Sulu klepelili koku tutucu
- 180 mm fileli flanşlı



140 MM 10x10 T.MEMBRANLI

Ürün Kodu	Kısa Kod	Çıkış	Ölçü	Fiyat
YAN ÇIKIŞ				
5054.TY032.10.1	14342	Ø 32	10x10 cm	320.00
5054.TY040.10.1	14346	Ø 40	10x10 cm	320.00
5054.TY050.10.1	14349	Ø 50	10x10 cm	320.00
5054.TY070.10.1	14351	Ø 70	10x10 cm	330.00
5054.TY100.10.1	14353	Ø 100	10x10 cm	373.40
ALT ÇIKIŞ				
5054.TA040.10.1	14356	Ø 40	10x10 cm	313.40
5054.TA050.10.1	14357	Ø 50	10x10 cm	316.70
5054.TA070.10.1	14359	Ø 70	10x10 cm	316.70
5054.TA100.10.1	14361	Ø 100	10x10 cm	323.40
S SIFONLU				
5154.TY050.10.1	34358	Ø 50	10x10 cm	490.00
İKİ ÇIKIŞLI				
5254.TY050.10.1	34359	Ø 50	10x10 cm	466.70
5254.TY070.10.1	34360	Ø 70	10x10 cm	466.70
DÖRT ÇIKIŞLI				
5454.TY050.10.1	34361	Ø 50	10x10 cm	473.40
5454.TY070.10.1	34362	Ø 70	10x10 cm	473.40

- Plastik gövde
- Paslanmaz ızgara
- Sulu klepeli koku tutucu
- 140 mm T. membranlı

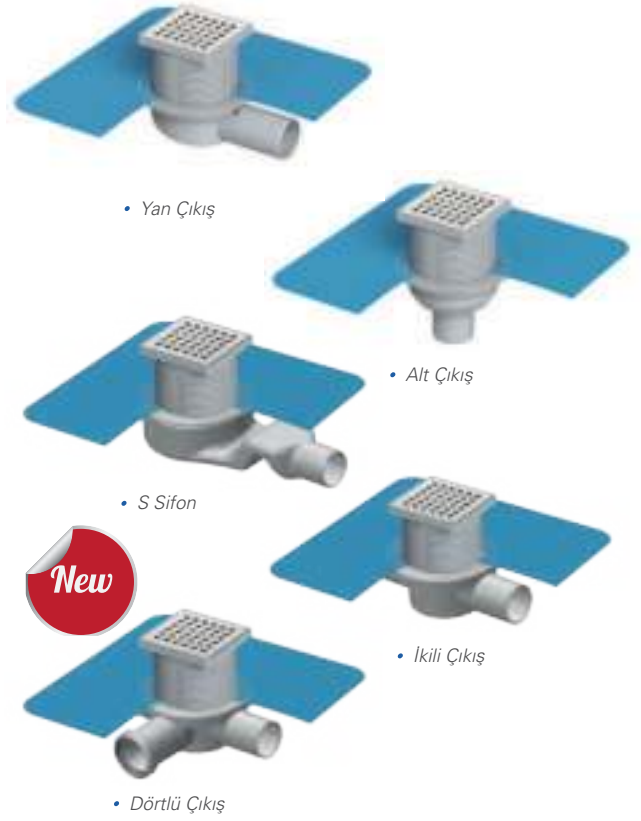

180 MM 10x10 T.MEMBRANLI

Ürün Kodu	Kısa Kod	Çıkış	Ölçü	Fiyat
YAN ÇIKIŞ				
5058.TY032.10.1	14345	Ø 32	10x10 cm	326.70
5058.TY040.10.1	14348	Ø 40	10x10 cm	326.70
5058.TY050.10.1	14350	Ø 50	10x10 cm	326.70
5058.TY070.10.1	14352	Ø 70	10x10 cm	346.70
5058.TY100.10.1	14354	Ø 100	10x10 cm	380.00
ALT ÇIKIŞ				
5058.TA040.10.1	14355	Ø 40	10x10 cm	323.40
5058.TA050.10.1	14358	Ø 50	10x10 cm	323.40
5058.TA070.10.1	14360	Ø 70	10x10 cm	333.40
5058.TA100.10.1	14362	Ø 100	10x10 cm	346.70
S SIFONLU				
5158.TY050.10.1	34363	Ø 50	10x10 cm	496.70
İKİ ÇIKIŞLI				
5258.TY050.10.1	34364	Ø 50	10x10 cm	473.40
5258.TY070.10.1	34365	Ø 70	10x10 cm	473.40
DÖRT ÇIKIŞLI				
5458.TY050.10.1	34366	Ø 50	10x10 cm	480.00
5458.TY070.10.1	34367	Ø 70	10x10 cm	480.00

- Plastik gövde
- Paslanmaz ızgara
- Sulu klepeli koku tutucu
- 180 mm T. membranlı

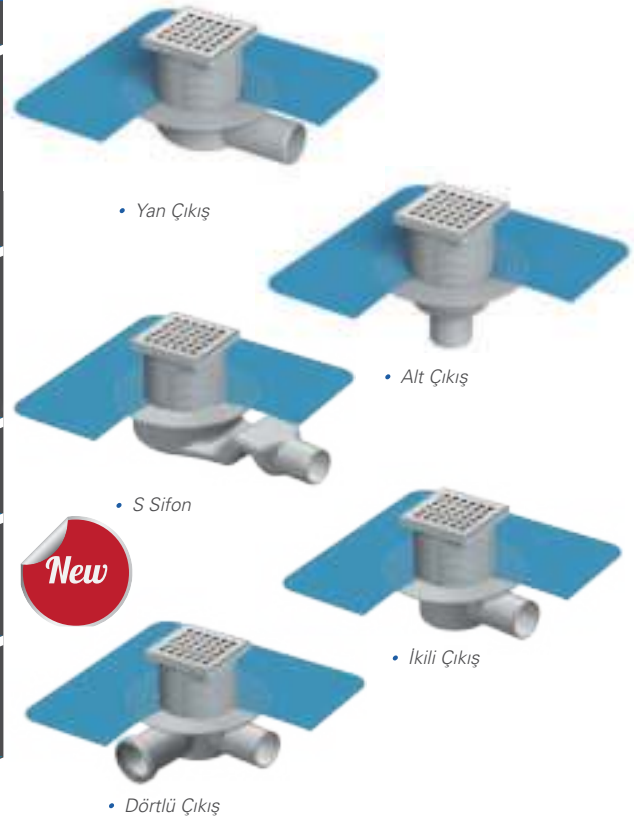

180 MM 15x15 T.MEMBRANLI

Ürün Kodu	Kısa Kod	Çıkış	Ölçü	İkili	Fiyat
YAN ÇIKIŞ					
5058.TY032.15.1	14364	Ø 32	15x15cm	50	416.70
5058.TY040.15.1	14365	Ø 40	15x15cm	50	416.70
5058.TY050.15.1	14366	Ø 50	15x15cm	50	416.70
5058.TY070.15.1	14367	Ø 70	15x15cm	30	446.70
5058.TY100.15.1	14368	Ø 100	15x15cm	20	496.70
ALT ÇIKIŞ					
5058.TA040.15.1	14369	Ø 40	15x15cm	50	410.00
5058.TA050.15.1	14370	Ø 50	15x15cm	50	410.00
5058.TA070.15.1	14371	Ø 70	15x15cm	40	420.00
5058.TA100.15.1	14372	Ø 100	15x15cm	30	433.40
S SIFONU					
5158.TY050.15.1	34368	Ø 50	15x15cm	30	596.70
İKİ ÇIKIŞLI					
5258.TY050.15.1	34369	Ø 50	15x15cm	20	563.40
5258.TY070.15.1	34370	Ø 70	15x15cm	20	563.40
DÖRT ÇIKIŞLI					
5458.TY050.15.1	34371	Ø 50	15x15cm	20	570.00
5458.TY070.15.1	34372	Ø 70	15x15cm	20	570.00

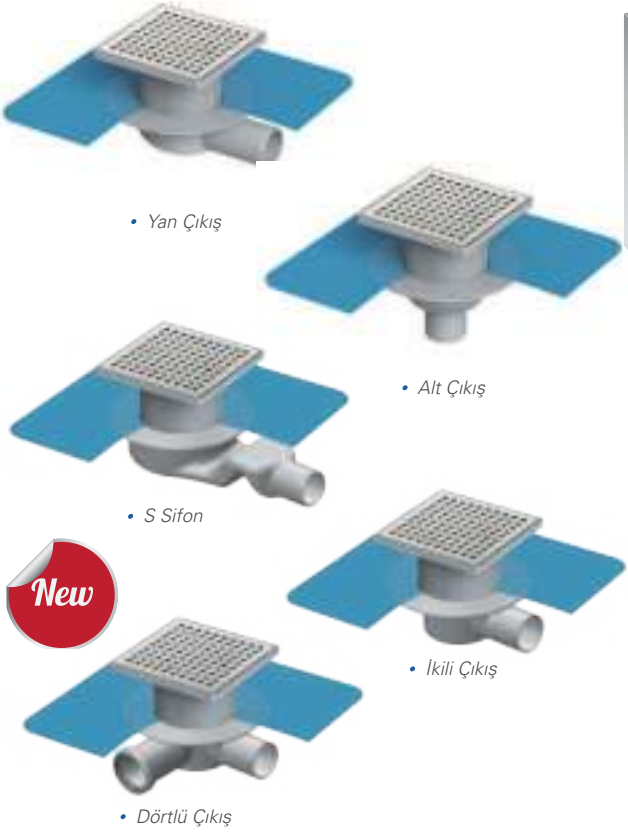

- Plastik gövde
- Paslanmaz ızgara
- Sulu klepeli koku tutucu
- 180 mm T. membranlı

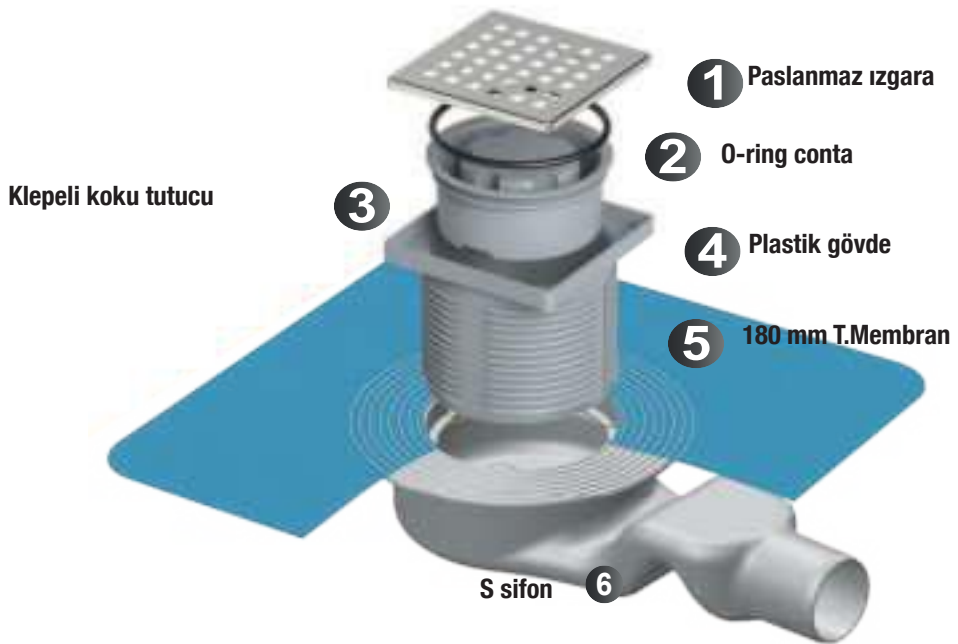

YALITIM UYUMLU SIFONLAR

210 MM 10x10 MEMBRANLI

Ürün Kodu	Kısa Kod	Çıkış	Ölçü	Fiyat	
YAN ÇIKIŞ					
5061.MY032.10.1	14363	Ø 32	10x10 cm	20	523.40
5061.MY040.10.1	14373	Ø 40	10x10 cm	20	523.40
5061.MY050.10.1	14374	Ø 50	10x10 cm	20	523.40
5061.MY070.10.1	14375	Ø 70	10x10 cm	20	536.70
5061.MY100.10.1	14377	Ø 100	10x10 cm	10	633.40
ALT ÇIKIŞ					
5061.MA040.10.1	14378	Ø 40	10x10 cm	20	520.00
5061.MA050.10.1	14379	Ø 50	10x10 cm	20	520.00
5061.MA070.10.1	14380	Ø 70	10x10 cm	20	520.00
5061.MA100.10.1	14385	Ø 100	10x10 cm	10	600.00

- Plastik gövde
- Paslanmaz ızgara
- Sulu klepeli koku tutucu
- 210 mm bitüm membranlı



210 MM 15x15 MEMBRANLI

Ürün Kodu	Kısa Kod	Çıkış	Ölçü	Fiyat	
YAN ÇIKIŞ					
5061.MY032.15.1	14376	Ø 32	15x15cm	20	610.00
5061.MY040.15.1	14381	Ø 40	15x15cm	20	610.00
5061.MY050.15.1	14382	Ø 50	15x15cm	20	610.00
5061.MY070.15.1	14383	Ø 70	15x15cm	20	620.00
5061.MY100.15.1	14384	Ø 100	15x15cm	10	716.70
ALT ÇIKIŞ					
5061.MA040.15.1	14386	Ø 40	15x15cm	20	606.70
5061.MA050.15.1	14388	Ø 50	15x15cm	20	606.70
5061.MA070.15.1	14390	Ø 70	15x15cm	20	606.70
5061.MA100.15.1	14392	Ø 100	15x15cm	10	683.40

- Plastik gövde
- Paslanmaz ızgara
- Sulu klepeli koku tutucu
- 210 mm bitüm membranlı





PARAPET

Ürün Kodu	Kısa Kod	Çap		Fiyat
YAN ÇIKIŞ				
8001.0A070.00.0	14387	Ø 70	30	150.00
8002.0A100.00.0	14389	Ø 100	25	183.40

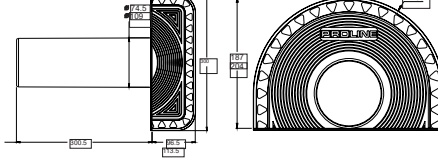

DİK İNİŞ

Ürün Kodu	Kısa Kod	Çap		Fiyat
8001.0A070.00.0	14387	Ø 70	30	150.00
8002.0A100.00.0	14389	Ø 100	25	183.40

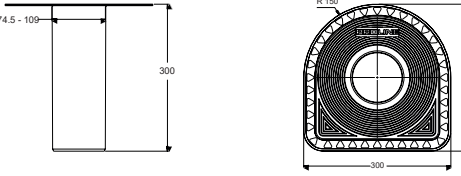

ÇATI HAVALANDIRMA

Ürün Kodu	Kısa Kod	Çap		Fiyat
ÇATI HAVALANDIRMA ŞAPKASI				
8003.0D070.00.0	14394	Ø 70	150	60.00
8004.0D100.00.0	14396	Ø 100	90	60.70
ÇATI HAVALANDIRMA SET				
8005.0D070.00.0	28907	Ø 70	30	193.40
8006.0D100.00.0	28908	Ø 100	25	236.70

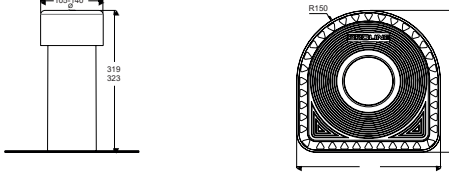

PARAPET ARA BAĞLANTI PARÇASI

Ürün Kodu	Kısa Kod	Çap		Fiyat
8201.0A070.10.0	14398	Ø 70	400	36.70
8202.0A100.10.0	14399	Ø 100	300	36.70

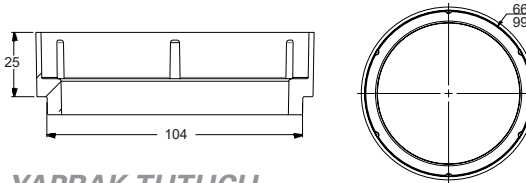

YAPRAK TUTUCU

Ürün Kodu	Kısa Kod	Çıkış		Fiyat
9302.0D070.00.0	31308	Ø 50-70	400	53.40
9302.0D100.00.0	14395	Ø 70-100	175	63.40

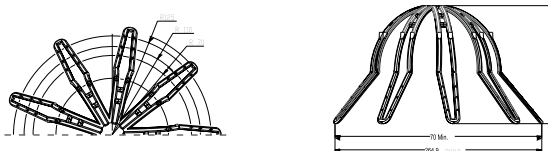

YALITIM UYUMLU SIFONLAR

MAXIFLOW
Maksimum akış...

PARAPET İKİZ GİDER

Ürün Kodu	Kısa Kod	Çap	Ölçü	Fiyat
10x10				
8101.0Y070.10.1	14400	Ø 70	10x10 cm	480.00
8101.0Y100.10.1	14402	Ø 100	10x10 cm	513.40
15x15				
8101.0Y070.15.1	14403	Ø 70	15x15 cm	573.40
8101.0Y100.15.1	14405	Ø 100	15x15 cm	606.70



- 8001- Ø 70 Parapet + 5014.0Y050.10.1 Sifon Takımı
- 8002- Ø 100 Parapet + 5014.0Y070.10.1 Sifon Takımı



- 8001- Ø 70 Parapet + 5018.0Y050.15.1 Sifon Takımı
- 8002- Ø 100 Parapet + 5018.0Y070.15.1 Sifon Takımı

DİK İNİŞ İKİZ GİDER

Ürün Kodu	Kısa Kod	Çap	Ölçü	Fiyat
10x10				
8102.0A070.10.1	14401	Ø 70	10x10 cm	423.40
8102.0A100.10.1	14404	Ø 100	10x10 cm	446.70
15x15				
8102.0A070.15.1	14406	Ø 70	15x15 cm	506.70
8102.0A100.15.1	14407	Ø 100	15x15 cm	530.00



- 8001- Ø 70 Parapet + 8201 Ara Bağlantı + 5101 Sifon Üst Gövde
- 8002- Ø 100 Parapet + 8202 Ara Bağlantı + 5101 Sifon Üst Gövde



- 8001- Ø 70 Parapet + 8201 Ara Bağlantı + 5101 Sifon Üst Gövde
- 8002- Ø 100 Parapet + 8202 Ara Bağlantı + 5101 Sifon Üst Gövde

SHINGLE HAVALANDIRMA

Ürün Kodu	Kısa Kod	Ölçü	Fiyat
8010.YD080.00.S	14408	Siyah 34x44x8.5 cm	253.40
8010.YD080.00.Y	14411	Yeşil 34x44x8.5 cm	266.70
8010.YD080.00.K	14412	Kırmızı 34x44x8.5 cm	266.70



- Polypropylene

KLASİK SERİSİ

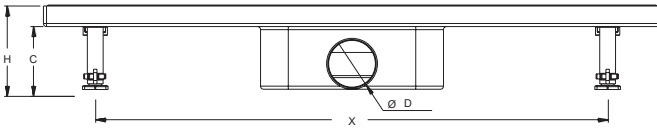

	W	L	H	Ø D	A	B	C	X	E
4012.0Y050K.020.1	205	72	88	49.5	196	64	68	-	1
4012.0Y050K.033.1	330	72	88	49.5	322	64	68	285	1
4012.0Y050K.040.1	400	72	88	49.5	392	64	68	335	1
4012.0Y050K.050.1	500	72	88	49.5	492	64	68	435	1
4012.0Y050K.060.1	600	72	88	49.5	592	64	68	556	1
4012.0Y050K.080.1	785	72	88	49.5	778	64	68	737	1

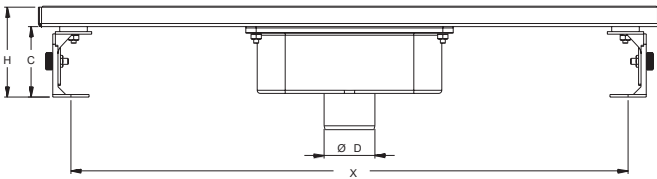

	W	L	H	Ø D	A	B	C	X	E
4012.0A050K.020.1	205	72	115	49.5	196	64	68	-	1
4012.0A050K.033.1	330	72	115	49.5	322	64	68	285	1
4012.0A050K.040.1	400	72	115	49.5	392	64	68	335	1
4012.0A050K.050.1	500	72	115	49.5	492	64	68	435	1
4012.0A050K.060.1	600	72	115	49.5	592	64	68	556	1
4012.0A050K.080.1	785	72	115	49.5	778	64	68	737	1

Detaylar

DN 50 Yan ve Alt çıkış – Pvc boru bağlantılarına uyumlu. sulu tip (36mm) koku önleyiciye sahiptir. Akış hızı 32 lt/dk'dır. Dış kimyasal etkilere dayanım çalışma sıcaklığı -30°+75° arasındır. Izgarası 304 kalite paslanmaz çeliktir.

Avantajlar

304 kalite paslanmaz çelik izgarası sayesinde şık ve kaliteli bir görünüme sahiptir. Duvar dibi uygulamalarda rahatlıkla uygulanabilir. Su tutuculu koku önleyici sayesinde tesisattan gelecek kötü kokuları önler. Yükseltme ayakları sayesinde şapın yüksekliğine göre ayarlama olanağı sağlar. Organik ve inorganik kimyasallara yüksek dayanım. çoğu asidik ve tuzlu su oksidasyonuna dayanıklıdır.

Kullanım Alanları

Genel kullanım banyo duşları. hastane ve otel duş alanları. soyunma odaları duş alanları vb.

Özel Üretim

Izgara modeli olarak isteğinize göre altın. bronz gibi renkler de üretilmektedir.

Uyarı

Yüksek yoğunluklu temizlik malzemelerinin uzun süreli kullanımı tavsiye edilmez.

LINE

Ürün Kodu	Kısa Kod	Çıkış	Ölçü	Fiyat
YAN ÇIKIŞ				
4012.0Y050K.020.1	14414	Ø 50	20 cm	12 400.00
4012.0Y050K.033.1	14431	Ø 50	33 cm	12 546.70
4012.0Y050K.040.1	14445	Ø 50	40 cm	12 606.70
4012.0Y050K.050.1	14465	Ø 50	50 cm	12 720.00
4012.0Y050K.060.1	14474	Ø 50	60 cm	12 796.70
4012.0Y050K.080.1	14491	Ø 50	80 cm	12 980.00
ALT ÇIKIŞ				
4012.0A050K.020.1	14415	Ø 50	20 cm	12 400.00
4012.0A050K.033.1	14430	Ø 50	33 cm	12 546.70
4012.0A050K.040.1	14448	Ø 50	40 cm	12 606.70
4012.0A050K.050.1	14463	Ø 50	50 cm	12 720.00
4012.0A050K.060.1	14488	Ø 50	60 cm	12 796.70
4012.0A050K.080.1	14503	Ø 50	80 cm	12 980.00

Duş kanalı / W200-330-400-500-600-800 mm / Ø 50 yan - alt çıkış
Plastik gövde / Paslanmaz ızgara / Sulu koku tutucu



HM-31361

Uzun koku tutucu kullanılmaktadır.

LINE ALÇAK SEVİYELİ

Ürün Kodu	Kısa Kod	Çıkış	Ölçü	Fiyat
ALÇAK SEVİYELİ				
4012.0Y050A.020.1	21668	Ø 50	20 cm	12 400.00
4012.0Y050A.033.1	21634	Ø 50	33 cm	12 546.70
4012.0Y050A.040.1	21645	Ø 50	40 cm	12 606.70
4012.0Y050A.050.1	21658	Ø 50	50 cm	12 720.00
4012.0Y050A.060.1	21684	Ø 50	60 cm	12 796.70
ALÇAK SEVİYELİ				
4012.0A050A.020.1	21536	Ø 50	20 cm	12 400.00
4012.0A050A.033.1	21552	Ø 50	33 cm	12 546.70
4012.0A050A.040.1	21565	Ø 50	40 cm	12 606.70
4012.0A050A.050.1	21575	Ø 50	50 cm	12 720.00
4012.0A050A.060.1	21585	Ø 50	60 cm	12 796.70

Duş kanalı / W200-330-400-500-600 mm / Ø 50 yan - alt çıkış
Plastik gövde / Paslanmaz ızgara / Sulu koku tutucu



HM-31362

Kısa koku tutucu kullanılmaktadır.



RAIN



KARE



BAHN



DOLU

Detaylar

DN 50 Yan ve Alt çıkış – Pvc boru bağlantılarına uyumlu. sulu tip (36mm) koku önleyiciye sahiptir. Akış hızı 32 lt/dk'dır. Dış kimyasal etkilere dayanım çalışma sıcaklığı -30°+75° arasındadır. Izgarası 304 kalite paslanmaz çeliktir.

Avantajlar

304 kalite paslanmaz çelik ızgarası sayesinde şık ve kaliteli bir görünüme sahiptir. Duvar dibi uygulamalarda rahatlıkla uygulanabilir. Su tutuculu koku önleyici sayesinde tesisattan gelecek kötü kokuları önler. Yükseltme ayakları sayesinde şapın yüksekliğine göre ayarlama olanağı sağlar. Organik ve inorganik kimyasallara yüksek dayanım. çoğu asidik ve tuzlu su oksidasyonuna dayanıklıdır.

Kullanım Alanları

Genel kullanım banyo duşları. hastane ve otel duş alanları. soyunma odaları duş alanları vb.

Özel Üretim

Izgara modeli olarak isteğinize göre altın, bronz gibi renkler de üretilmektedir.

Uyarı

Yüksek yoğunluklu temizlik malzemelerinin uzun süreli kullanımı tavsiye edilmez.

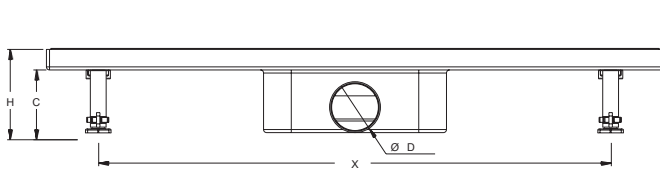
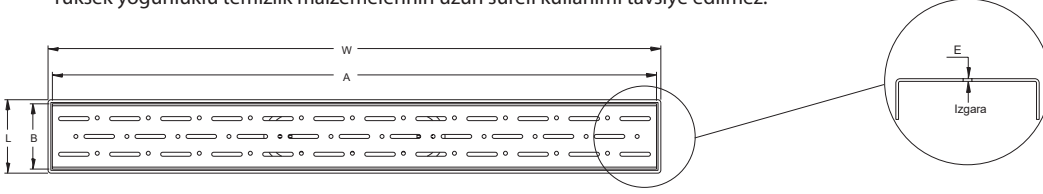

	W	L	H	Ø D	A	B	C	X	E
4012.0Y050K.020.1	205	72	88	49.5	196	64	68	-	1
4012.0Y050K.033.1	330	72	88	49.5	322	64	68	285	1
4012.0Y050K.040.1	400	72	88	49.5	392	64	68	335	1
4012.0Y050K.050.1	500	72	88	49.5	492	64	68	435	1
4012.0Y050K.060.1	600	72	88	49.5	592	64	68	556	1
4012.0Y050K.080.1	785	72	88	49.5	778	64	68	737	1

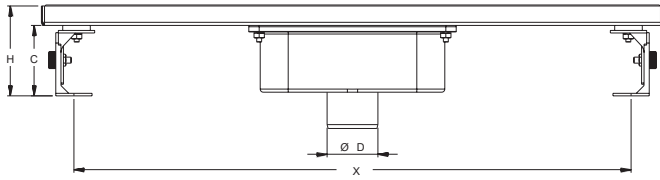

	W	L	H	Ø D	A	B	C	X	E
4012.0A050K.020.1	205	72	115	49.5	196	64	68	-	1
4012.0A050K.033.1	330	72	115	49.5	322	64	68	285	1
4012.0A050K.040.1	400	72	115	49.5	392	64	68	335	1
4012.0A050K.050.1	500	72	115	49.5	492	64	68	435	1
4012.0A050K.060.1	600	72	115	49.5	592	64	68	556	1
4012.0A050K.080.1	785	72	115	49.5	778	64	68	737	1



LEGAL

Ürün Kodu	Kısa Kod	Çıkış	Ölçü	İkili	Fiyat
YAN ÇIKIŞ					
4013.0Y050K.020.1	14602	Ø 50	20 cm	12	633.40
4013.0Y050K.033.1	14613	Ø 50	33 cm	12	986.70
4013.0Y050K.040.1	14626	Ø 50	40 cm	12	1090.00
4013.0Y050K.050.1	14636	Ø 50	50 cm	12	1286.70
4013.0Y050K.060.1	14649	Ø 50	60 cm	12	1470.00
4013.0Y050K.080.1	14668	Ø 50	80 cm	12	1810.00
ALT ÇIKIŞ					
4013.0A050K.020.1	14651	Ø 50	20 cm	12	633.40
4013.0A050K.033.1	14667	Ø 50	33 cm	12	986.70
4013.0A050K.040.1	14685	Ø 50	40 cm	12	1090.00
4013.0A050K.050.1	14701	Ø 50	50 cm	12	1286.70
4013.0A050K.060.1	14722	Ø 50	60 cm	12	1470.00
4013.0A050K.080.1	14734	Ø 50	80 cm	12	1810.00

Duş kanalı / W200-330-400-500-600-800 mm / Ø 50 yan - alt çıkış
Paslanmaz gövde / Paslanmaz ızgara / Sulu koku tutucu

LEGAL Y360°

Ürün Kodu	Kısa Kod	Çıkış	Ölçü	İkili	Fiyat
YAN ÇIKIŞ					
4013.0Y360K.020.1	14879	Ø 50	20 cm	12	770.00
4013.0Y360K.033.1	14902	Ø 50	33 cm	12	1113.40
4013.0Y360K.040.1	14916	Ø 50	40 cm	12	1210.00
4013.0Y360K.050.1	14928	Ø 50	50 cm	12	1406.70
4013.0Y360K.060.1	14937	Ø 50	60 cm	12	1593.40
4013.0Y360K.080.1	14946	Ø 50	80 cm	12	1906.70
ALT ÇIKIŞ					
4013.0A360K.020.1	14971	Ø 50	20 cm	12	770.00
4013.0A360K.033.1	14994	Ø 50	33 cm	12	1113.40
4013.0A360K.040.1	15007	Ø 50	40 cm	12	1210.00
4013.0A360K.050.1	15027	Ø 50	50 cm	12	1406.70
4013.0A360K.060.1	15038	Ø 50	60 cm	12	1593.40
4013.0A360K.080.1	15050	Ø 50	80 cm	12	1906.70

Duş kanalı / W200-330-400-500-600-800 mm / Ø 50 yan - alt çıkış
Paslanmaz gövde / Paslanmaz ızgara / Sulu koku tutucu



HM-31363

Legal koku tutucu kullanılmaktadır.



HM-31363

Legal koku tutucu kullanılmaktadır.



KLASİK SİMPLE LEGAL



HM-31359

Style koku tutucu kullanılmaktadır.

Ürün Kodu	Kısa Kod	Çıkış	Ölçü		Fiyat
4013.0Y050P020.1	23264	Ø 50	20 cm	12	596.70
4013.0Y050P033.1	23289	Ø 50	33 cm	12	810.00
4013.0Y050P040.1	23297	Ø 50	40 cm	12	910.00
4013.0Y050P050.1	23312	Ø 50	50 cm	12	1100.00
4013.0Y050P060.1	23320	Ø 50	60 cm	12	1276.70
4013.0Y050P080.1	23337	Ø 50	80 cm	12	1596.70

Duş kanalı / W200-330-400-500-600-800 mm / Ø 50 yan - alt çıkış
Paslanmaz gövde / Paslanmaz ızgara / Sulu koku tutucu



HM-31359

Style koku tutucu kullanılmaktadır.

KLASİK SİMPLE LEGAL SİFONİK

Ürün Kodu	Kısa Kod	Çıkış	Ölçü		Fiyat
4115.0Y050P020.1	34687	Ø 50	20 cm	12	920.00
4115.0Y050P033.1	34688	Ø 50	33 cm	12	1240.00
4115.0Y050P040.1	34689	Ø 50	40 cm	12	1336.70
4115.0Y050P050.1	34690	Ø 50	50 cm	12	1530.00
4115.0Y050P060.1	34691	Ø 50	60 cm	12	1716.70
4115.0Y050P080.1	34692	Ø 50	80 cm	12	2060.00

Duş kanalı / W200-330-400-500-600-800 mm / Ø 50 yan - alt çıkış
Paslanmaz gövde / Paslanmaz ızgara / Sulu koku tutucu

LEGAL



HM-31359

Style koku tutucu kullanılmaktadır.

Ürün Kodu	Kısa Kod	Çıkış	Ölçü		Fiyat
YAN ÇIKIŞ					
4015.0Y050P020.1	31213	Ø 50	20 cm	12	753.40
4015.0Y050P033.1	31217	Ø 50	33 cm	12	1033.40
4015.0Y050P040.1	31221	Ø 50	40 cm	12	1133.40
4015.0Y050P050.1	31225	Ø 50	50 cm	12	1326.70
4015.0Y050P060.1	31229	Ø 50	60 cm	12	1510.00
4015.0Y050P080.1	31233	Ø 50	80 cm	12	1826.70
ALT ÇIKIŞ					
4015.0A050P020.1	31237	Ø 50	20 cm	12	753.40
4015.0A050P033.1	31241	Ø 50	33 cm	12	1033.40
4015.0A050P040.1	31245	Ø 50	40 cm	12	1133.40
4015.0A050P050.1	31248	Ø 50	50 cm	12	1326.70
4015.0A050P060.1	31253	Ø 50	60 cm	12	1510.00
4015.0A050P080.1	31257	Ø 50	80 cm	12	1826.70

Duş kanalı / W200-330-400-500-600-800 mm / Ø 50 yan - alt çıkış
Paslanmaz gövde / Paslanmaz ızgara / Sulu koku tutucu

LEGAL Y360° S SIFON

Ürün Kodu	Kısa Kod	Çıkış	Ölçü	Fiyat
YAN ÇIKIŞ				
4118.0Y050P020.1	34693	Ø 50	20 cm	1016.70
4118.0Y050P033.1	34694	Ø 50	33 cm	1356.70
4118.0Y050P040.1	34695	Ø 50	40 cm	1450.00
4118.0Y050P050.1	34696	Ø 50	50 cm	1646.70
4118.0Y050P060.1	34697	Ø 50	60 cm	1833.40
4118.0Y050P080.1	34698	Ø 50	80 cm	2180.00

Duş kanalı / W200-330-400-500-600-800 mm / Ø 50 yan - alt çıkış
Paslanmaz gövde / Paslanmaz ızgara / Sulu koku tutucu



HM-31359

Style koku tutucu kullanılmaktadır.

LEGAL Y360°

Ürün Kodu	Kısa Kod	Çıkış	Ölçü	Fiyat
YAN ÇIKIŞ				
4018.0Y050P020.1	31273	Ø 50	20 cm	850.00
4018.0Y050P033.1	31277	Ø 50	33 cm	1186.70
4018.0Y050P040.1	31281	Ø 50	40 cm	1283.40
4018.0Y050P050.1	31285	Ø 50	50 cm	1480.00
4018.0Y050P060.1	31289	Ø 50	60 cm	1666.70
4018.0Y050P080.1	31293	Ø 50	80 cm	2013.40

ALT ÇIKIŞ

4018.0A050P020.1	31487	Ø 50	20 cm	850.00
4018.0A050P033.1	31491	Ø 50	33 cm	1186.70
4018.0A050P040.1	31495	Ø 50	40 cm	1283.40
4018.0A050P050.1	31499	Ø 50	50 cm	1480.00
4018.0A050P060.1	31503	Ø 50	60 cm	1666.70
4018.0A050P080.1	31507	Ø 50	80 cm	2013.40

Duş kanalı / W200-330-400-500-600-800 mm / Ø 50 yan - alt çıkış
Paslanmaz gövde / Paslanmaz ızgara / Sulu koku tutucu



HM-31359

Style koku tutucu kullanılmaktadır.



SCALA



HM-31363

Legal koku tutucu kullanılmaktadır.

Ürün Kodu	Kısa Kod	Çıkış	Ölçü		Fiyat
YAN ÇIKIŞ					
4014.0Y050K.020.1	15086	Ø 50	20 cm	12	623.40
4014.0Y050K.033.1	15087	Ø 50	33 cm	12	970.00
4014.0Y050K.040.1	15088	Ø 50	40 cm	12	1056.70
4014.0Y050K.050.1	15090	Ø 50	50 cm	12	1256.70
4014.0Y050K.060.1	15092	Ø 50	60 cm	12	1433.40
4014.0Y050K.080.1	15095	Ø 50	80 cm	12	1743.40
ALT ÇIKIŞ					
4014.0A050K.020.1	15072	Ø 50	20 cm	12	623.40
4014.0A050K.033.1	15076	Ø 50	33 cm	12	970.00
4014.0A050K.040.1	15078	Ø 50	40 cm	12	1056.70
4014.0A050K.050.1	15080	Ø 50	50 cm	12	1256.70
4014.0A050K.060.1	15082	Ø 50	60 cm	12	1433.40
4014.0A050K.080.1	15084	Ø 50	80 cm	12	1743.40

Duş kanalı / W200-330-400-500-600-800 mm / Ø 50 yan - alt çıkış
Paslanmaz gövde / Paslanmaz seramik uyumlu çerçeve / Sulu koku tutucu

SCALA Y360°



HM-31363

Legal koku tutucu kullanılmaktadır.

Ürün Kodu	Kısa Kod	Çıkış	Ölçü		Fiyat
YAN ÇIKIŞ					
4014.0Y360K.020.1	15110	Ø 50	20 cm	12	750.00
4014.0Y360K.033.1	15112	Ø 50	33 cm	12	1080.00
4014.0Y360K.040.1	15114	Ø 50	40 cm	12	1163.40
4014.0Y360K.050.1	15116	Ø 50	50 cm	12	1360.00
4014.0Y360K.060.1	15117	Ø 50	60 cm	12	1536.70
4014.0Y360K.080.1	15118	Ø 50	80 cm	12	1853.40
ALT ÇIKIŞ					
4014.0A360K.020.1	31365	Ø 50	20 cm	12	750.00
4014.0A360K.033.1	31366	Ø 50	33 cm	12	1080.00
4014.0A360K.040.1	31367	Ø 50	40 cm	12	1163.40
4014.0A360K.050.1	31368	Ø 50	50 cm	12	1360.00
4014.0A360K.060.1	31369	Ø 50	60 cm	12	1536.70
4014.0A360K.080.1	31370	Ø 50	80 cm	12	1853.40

Duş kanalı / W200-330-400-500-600-800 mm / Ø 50 yan - alt çıkış
Paslanmaz gövde / Paslanmaz seramik uyumlu çerçeve / Sulu koku tutucu

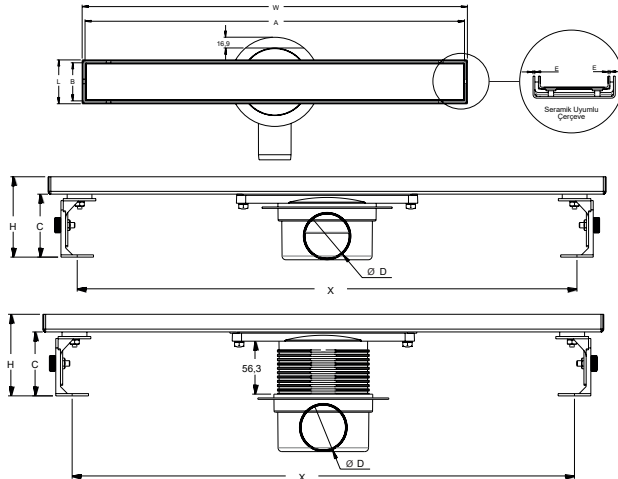

ÜRÜN KODU

ÜRÜN KODU	W	L	H	Ø D	A	B	C	X	E
4014.00360K.033.1	330	72	88	49.5	316	58	68	285	1
4014.00360K.040.1	400	72	88	49.5	388	58	68	335	1
4014.00360K.050.1	500	72	88	49.5	487	58	68	435	1
4014.00360K.060.1	600	72	88	49.5	589	58	68	556	1
4014.00360K.080.1	785	72	88	49.5	773	58	68	737	1

ÜRÜN KODU

ÜRÜN KODU	W	L	H	Ø D	A	B	C	X	E
4014.0Y360K.033.1	330	72	154	49.5	316	58	68	285	1
4014.0Y360K.040.1	400	72	154	49.5	388	58	68	335	1
4014.0Y360K.050.1	500	72	154	49.5	487	58	68	435	1
4014.0Y360K.060.1	600	72	154	49.5	589	58	68	556	1
4014.0Y360K.080.1	785	72	154	49.5	773	58	68	737	1

Tablo ölçü birimi "mm"dir.

STYLE SERİSİ

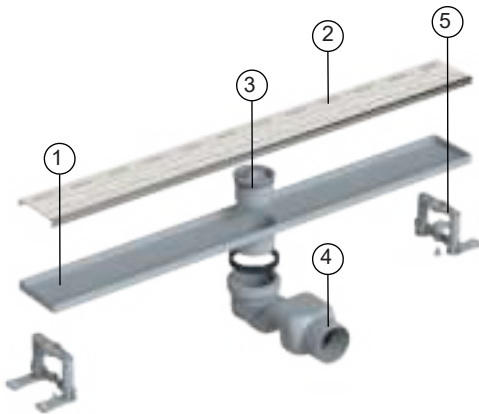

PARÇA NO	PARÇA AÇIKLAMASI	MALZEME	ADET
4083.1	Paslanmaz Üst Gövde	AISI 304	1
4083.2	Paslanmaz Izgara	AISI 304	1
4083.3	Koku Tutucu	PP	1
4083.4	S Sifon	PP	1
4083.5	Yükseklik Ayarlı Montaj Seti	PP	2

Detaylar

DN 50 Yan ve Alt çıkış – Pvc boru bağlantılarına uyumludur. Akış hızı 32 lt/dk'dır. Izgarası 304 kalite paslanmaz çeliktir.

Avantajlar

304 kalite paslanmaz çelik ızgarası sayesinde şık ve kaliteli bir görünüme sahiptir. Duvar dibi uygulamalarda rahatlıkla uygulanabilir. Su tutuculu koku önleyici sayesinde tesisattan gelecek kötü kokuları önler. Yükseltme ayakları sayesinde şapın yüksekliğine göre ayarlama olanağı sağlar. Organik ve inorganik kimyasallara yüksek dayanım. çoğu asidik ve tuzlu su oksidasyonuna dayanıklıdır.

Kullanım Alanları

Genel kullanım banyo duşları, hastane ve otel duş alanları, soyunma odaları duş alanları vb.

Özel Üretim

Izgara modeli olarak isteğinize göre altın, bronz gibi renkler de üretilmektedir.

Uyarı

Yüksek yoğunluklu temizlik malzemelerinin uzun süreli kullanımı tavsiye edilmez.

SIMPLE LINE



HM-31359

Style koku tutucu kullanılmaktadır.

Ürün Kodu	Kısa Kod	Çıkış	Ölçü	Fiyat
ALT ÇIKIŞ				
4080.0A050K.033.1	15119	Ø 50	33 cm	376.70
4080.0A050K.040.1	15148	Ø 50	40 cm	450.00
4080.0A050K.050.1	15162	Ø 50	50 cm	546.70
4080.0A050K.060.1	15199	Ø 50	60 cm	610.00
4080.0A050K.080.1	15216	Ø 50	80 cm	723.40

Duş kanalı / W330-400-500-600-800 mm / Ø 50 yan - alt çıkış
Plastik gövde / Paslanmaz ızgara / Sulu koku tutucu

LINE S SIFON

New



HM-31359

Style koku tutucu kullanılmaktadır.

Ürün Kodu	Kısa Kod	Çıkış	Ölçü	Fiyat
YAN ÇIKIŞ				
4181.0Y050K.033.1	34699	Ø 50	33 cm	710.00
4181.0Y050K.040.1	34700	Ø 50	40 cm	780.00
4181.0Y050K.050.1	34701	Ø 50	50 cm	880.00
4181.0Y050K.060.1	34702	Ø 50	60 cm	950.00
4181.0Y050K.080.1	34703	Ø 50	80 cm	1090.00

Duş kanalı / W330-400-500-600-800 mm / Ø 50 yan - alt çıkış
Plastik gövde / Paslanmaz ızgara / Sulu koku tutucu

LINE



HM-31359

Style koku tutucu kullanılmaktadır.

Ürün Kodu	Kısa Kod	Çıkış	Ölçü	Fiyat
YAN ÇIKIŞ				
4081.0Y050K.033.1	15160	Ø 50	33 cm	510.00
4081.0Y050K.040.1	15172	Ø 50	40 cm	586.70
4081.0Y050K.050.1	15187	Ø 50	50 cm	683.40
4081.0Y050K.060.1	15197	Ø 50	60 cm	750.00
4081.0Y050K.080.1	15213	Ø 50	80 cm	863.40

ALT ÇIKIŞ

4082.0A050K.033.1	15228	Ø 50	33 cm	510.00
4082.0A050K.040.1	15239	Ø 50	40 cm	586.70
4082.0A050K.050.1	15254	Ø 50	50 cm	683.40
4082.0A050K.060.1	15269	Ø 50	60 cm	750.00
4082.0A050K.080.1	15295	Ø 50	80 cm	863.40

Duş kanalı / W330-400-500-600-800 mm / Ø 50 yan - alt çıkış
Plastik gövde / Paslanmaz ızgara / Sulu koku tutucu



RAIN



KARE



BAHN

LINE FİLELİ S SIFON

Ürün Kodu	Kısa Kod	Çıkış	Ölçü	Fiyat	
YAN ÇIKIŞ					
4192.FY050K.033.1	34704	Ø 50	33 cm	12	753.40
4192.FY050K.040.1	34705	Ø 50	40 cm	12	826.70
4192.FY050K.050.1	34706	Ø 50	50 cm	12	926.70
4192.FY050K.060.1	34707	Ø 50	60 cm	12	993.40
4192.FY050K.080.1	34708	Ø 50	80 cm	12	1136.70

Duș kanalı / W-330-400-500-600-800 mm / Ø 50 yan - alt çıkış
Plastik gövde / Paslanmaz ızgara / Sulu koku tutucu

LINE FİLELİ

Ürün Kodu	Kısa Kod	Çıkış	Ölçü	Fiyat	
YAN ÇIKIŞ					
4092.FY050K.033.1	15585	Ø 50	33 cm	12	593.40
4092.FY050K.040.1	15603	Ø 50	40 cm	12	663.40
4092.FY050K.050.1	15623	Ø 50	50 cm	12	763.40
4092.FY050K.060.1	15637	Ø 50	60 cm	12	833.40
4092.FY050K.080.1	15647	Ø 50	80 cm	12	973.40
ALT ÇIKIŞ					
4093.FA050K.033.1	15591	Ø 50	33 cm	12	593.40
4093.FA050K.040.1	15613	Ø 50	40 cm	12	663.40
4093.FA050K.050.1	15635	Ø 50	50 cm	12	763.40
4093.FA050K.060.1	15662	Ø 50	60 cm	12	833.40
4093.FA050K.080.1	15698	Ø 50	80 cm	12	973.40

Duș kanalı / W330-400-500-600-800 mm / Ø 50 yan - alt çıkış
Plastik gövde / Paslanmaz ızgara / Sulu koku tutucu

STYLE SİFONİK

Ürün Kodu	Kısa Kod	Çıkış	Ölçü	Fiyat	
YAN ÇIKIŞ					
4083.0Y050K.033.1	15243	Ø 50	33 cm	12	490.00
4083.0Y050K.040.1	15270	Ø 50	40 cm	12	566.70
4083.0Y050K.050.1	15282	Ø 50	50 cm	12	663.40
4083.0Y050K.060.1	15300	Ø 50	60 cm	12	730.00
4083.0Y050K.080.1	15312	Ø 50	80 cm	12	846.70

Duș kanalı / W330-400-500-600-800 mm / Ø 50 yan - alt çıkış
Plastik gövde / Paslanmaz ızgara / Sulu koku tutucu

LINE Y360° S SIFON

Ürün Kodu	Kısa Kod	Çıkış	Ölçü	Fiyat	
YAN ÇIKIŞ					
4185.0Y050K.033.1	34709	Ø 50	33 cm	12	796.70
4185.0Y050K.040.1	34710	Ø 50	40 cm	12	883.40
4185.0Y050K.050.1	34711	Ø 50	50 cm	12	996.70
4185.0Y050K.060.1	34712	Ø 50	60 cm	12	1066.70
4185.0Y050K.080.1	34713	Ø 50	80 cm	12	1223.40

Duș kanalı / W-330-400-500-600-800 mm / Ø 50 yan - alt çıkış
Plastik gövde / Paslanmaz ızgara / Sulu koku tutucu

New



HM-31359

Style koku tutucu kullanılmaktadır.



HM-31359

Style koku tutucu kullanılmaktadır.



HM-31359

Style koku tutucu kullanılmaktadır.



HM-31359

Style koku tutucu kullanılmaktadır.



HM-31359

Style koku tutucu kullanılmaktadır.



HM-31359

Style koku tutucu kullanılmaktadır.



HM-31359

Style koku tutucu kullanılmaktadır.



RAIN

KARE

BAHN

LINE Y360°

Ürün Kodu	Kısa Kod	Çıkış	Ölçü		Fiyat
YAN ÇIKIŞ					
4085.0Y050K.033.1	29857	Ø 50	33 cm	12	633.40
4085.0Y050K.040.1	29860	Ø 50	40 cm	12	723.40
4085.0Y050K.050.1	29863	Ø 50	50 cm	12	833.40
4085.0Y050K.060.1	29866	Ø 50	60 cm	12	906.70
4085.0Y050K.080.1	29869	Ø 50	80 cm	12	1063.40
ALT ÇIKIŞ					
4085.0A050K.033.1	29872	Ø 50	33 cm	12	633.40
4085.0A050K.040.1	29875	Ø 50	40 cm	12	723.40
4085.0A050K.050.1	29878	Ø 50	50 cm	12	833.40
4085.0A050K.060.1	29881	Ø 50	60 cm	12	906.70
4085.0A050K.080.1	29884	Ø 50	80 cm	12	1063.40

Duş kanalı / W330-400-500-600-800 mm / Ø 50 yan - alt çıkış
Plastik gövde / Paslanmaz ızgara / Sulu koku tutucu

LINE FİLELİ Y360° S SIFON

Ürün Kodu	Kısa Kod	Çıkış	Ölçü		Fiyat
YAN ÇIKIŞ					
4185.FY050K.033.1	34714	Ø 50	33 cm	12	816.70
4185.FY050K.040.1	34715	Ø 50	40 cm	12	886.70
4185.FY050K.050.1	34716	Ø 50	50 cm	12	986.70
4185.FY050K.060.1	34717	Ø 50	60 cm	12	1056.70
4185.FY050K.080.1	34718	Ø 50	80 cm	12	1196.70

Duş kanalı / W330-400-500-600-800 mm / Ø 50 yan - alt çıkış
Plastik gövde / Paslanmaz ızgara / Sulu koku tutucu

LINE FİLELİ Y360°

Ürün Kodu	Kısa Kod	Çıkış	Ölçü		Fiyat
YAN ÇIKIŞ					
4090.FY050K.033.1	29935	Ø 50	33 cm	12	653.40
4090.FY050K.040.1	29939	Ø 50	40 cm	12	726.70
4090.FY050K.050.1	29943	Ø 50	50 cm	12	826.70
4090.FY050K.060.1	29947	Ø 50	60 cm	12	893.40
4090.FY050K.080.1	29951	Ø 50	80 cm	12	1036.70
ALT ÇIKIŞ					
4090.FA050K.033.1	29955	Ø 50	33 cm	12	653.40
4090.FA050K.040.1	29959	Ø 50	40 cm	12	726.70
4090.FA050K.050.1	29963	Ø 50	50 cm	12	826.70
4090.FA050K.060.1	29967	Ø 50	60 cm	12	893.40
4090.FA050K.080.1	29971	Ø 50	80 cm	12	1036.70

Duş kanalı / W330-400-500-600-800 mm / Ø 50 yan - alt çıkış
Plastik gövde / Paslanmaz ızgara / Sulu koku tutucu

SIMPLE LEGAL

Ürün Kodu	Kısa Kod	Çıkış	Ölçü	Fiyat
ALT ÇIKIŞ				
4086.0A050K.020.1	15329	Ø 50	20 cm	553.40
4086.0A050K.033.1	15338	Ø 50	33 cm	750.00
4086.0A050K.040.1	15347	Ø 50	40 cm	843.40
4086.0A050K.050.1	15363	Ø 50	50 cm	1016.70
4086.0A050K.060.1	15381	Ø 50	60 cm	1173.40
4086.0A050K.080.1	15420	Ø 50	80 cm	1453.40

Duş kanalı / W200-330-400-500-600-800 mm / Ø 50 yan - alt çıkış
Paslanmaz gövde / Paslanmaz ızgara / Sulu koku tutucu



HM-31359

Style koku tutucu kullanılmaktadır.

LEGAL S SİFON

Ürün Kodu	Kısa Kod	Çıkış	Ölçü	Fiyat
YAN ÇIKIŞ				
4187.0Y050K.020.1	34719	Ø 50	20 cm	870.00
4187.0Y050K.033.1	34720	Ø 50	33 cm	1060.00
4187.0Y050K.040.1	34721	Ø 50	40 cm	1150.00
4187.0Y050K.050.1	34722	Ø 50	50 cm	1326.70
4187.0Y050K.060.1	34723	Ø 50	60 cm	1486.70
4187.0Y050K.080.1	34724	Ø 50	80 cm	1796.70

Duş kanalı / W200-330-400-500-600-800 mm / Ø 50 yan - alt çıkış
Paslanmaz gövde / Paslanmaz ızgara / Sulu koku tutucu



HM-31359

Style koku tutucu kullanılmaktadır.

LEGAL

Ürün Kodu	Kısa Kod	Çıkış	Ölçü	Fiyat
YAN ÇIKIŞ				
4087.0Y050K.020.1	15445	Ø 50	20 cm	656.70
4087.0Y050K.033.1	15471	Ø 50	33 cm	853.40
4087.0Y050K.040.1	15490	Ø 50	40 cm	946.70
4087.0Y050K.050.1	15508	Ø 50	50 cm	1123.40
4087.0Y050K.060.1	15532	Ø 50	60 cm	1280.00
4087.0Y050K.080.1	15580	Ø 50	80 cm	1563.40
ALT ÇIKIŞ				
4088.0A050K.020.1	15321	Ø 50	20 cm	656.70
4088.0A050K.033.1	15366	Ø 50	33 cm	853.40
4088.0A050K.040.1	15383	Ø 50	40 cm	946.70
4088.0A050K.050.1	15396	Ø 50	50 cm	1123.40
4088.0A050K.060.1	15417	Ø 50	60 cm	1280.00
4088.0A050K.080.1	15446	Ø 50	80 cm	1563.40

Duş kanalı / W200-330-400-500-600-800 mm / Ø 50 yan - alt çıkış
Paslanmaz gövde / Paslanmaz ızgara / Sulu koku tutucu



HM-31359

Style koku tutucu kullanılmaktadır.



RAIN



KARE



BAHN



DOLU

LEGAL FİLELİ S SIFON

Ürün Kodu	Kısa Kod	Çıkış	Ölçü	Fiyat
YAN ÇIKIŞ				
4194.FY050K.020.1	34725	Ø 50	20 cm	916.70
4194.FY050K.033.1	34726	Ø 50	33 cm	1106.70
4194.FY050K.040.1	34727	Ø 50	40 cm	1196.70
4194.FY050K.050.1	34728	Ø 50	50 cm	1373.40
4194.FY050K.060.1	34729	Ø 50	60 cm	1533.40
4194.FY050K.080.1	34730	Ø 50	80 cm	1843.40

Duş kanalı / W330-400-500-600-800 mm / Ø 50 yan - alt çıkış
Paslanmaz gövde / Paslanmaz ızgara / Sulu koku tutucu



HM-31359

Style koku tutucu kullanılmaktadır.

LEGAL FİLELİ

Ürün Kodu	Kısa Kod	Çıkış	Ölçü	Fiyat
YAN ÇIKIŞ				
4094.FY050K.020.1	15665	Ø 50	20 cm	750.00
4094.FY050K.033.1	15680	Ø 50	33 cm	940.00
4094.FY050K.040.1	15692	Ø 50	40 cm	1026.70
4094.FY050K.050.1	15706	Ø 50	50 cm	1206.70
4094.FY050K.060.1	15731	Ø 50	60 cm	1363.40
4094.FY050K.080.1	15784	Ø 50	80 cm	1676.70
ALT ÇIKIŞ				
4094.FA050K.020.1	15714	Ø 50	20 cm	750.00
4094.FA050K.033.1	15728	Ø 50	33 cm	940.00
4094.FA050K.040.1	15740	Ø 50	40 cm	1026.70
4094.FA050K.050.1	15754	Ø 50	50 cm	1206.70
4094.FA050K.060.1	15767	Ø 50	60 cm	1363.40
4094.FA050K.080.1	15793	Ø 50	80 cm	1676.70

Duş kanalı / W200-330-400-500-600-800 mm / Ø 50 yan - alt çıkış
Paslanmaz gövde / Paslanmaz ızgara / Sulu koku tutucu



HM-31359

Style koku tutucu kullanılmaktadır.



LEGAL SİFONİK

Ürün Kodu	Kısa Kod	Çıkış	Ölçü		Fiyat
YAN ÇIKIŞ					
4084.0Y050K.020.1	15457	Ø 50	20 cm	12	636.70
4084.0Y050K.033.1	15479	Ø 50	33 cm	12	833.40
4084.0Y050K.040.1	15495	Ø 50	40 cm	12	926.70
4084.0Y050K.050.1	15517	Ø 50	50 cm	12	1103.40
4084.0Y050K.060.1	15536	Ø 50	60 cm	12	1260.00
4084.0Y050K.080.1	15565	Ø 50	80 cm	12	1543.40

Duş kanalı / W200-330-400-500-600-800 mm / Ø 50 yan - alt çıkış
Paslanmaz gövde / Paslanmaz ızgara / Sulu koku tutucu



HM-31359

Style koku tutucu kullanılmaktadır.

LEGAL Y360° S SİFON

Ürün Kodu	Kısa Kod	Çıkış	Ölçü		Fiyat
YAN ÇIKIŞ					
4189.0Y050K.020.1	34731	Ø 50	20 cm	12	956.70
4189.0Y050K.033.1	34732	Ø 50	33 cm	12	1150.00
4189.0Y050K.040.1	34733	Ø 50	40 cm	12	1236.70
4189.0Y050K.050.1	34734	Ø 50	50 cm	12	1416.70
4189.0Y050K.060.1	34735	Ø 50	60 cm	12	1573.40
4189.0Y050K.080.1	34736	Ø 50	80 cm	12	1886.70

Duş kanalı / W200-330-400-500-600-800 mm / Ø 50 yan - alt çıkış
Paslanmaz gövde / Paslanmaz ızgara / Sulu koku tutucu



HM-31359

Style koku tutucu kullanılmaktadır.

LEGAL Y360°

Ürün Kodu	Kısa Kod	Çıkış	Ölçü		Fiyat
YAN ÇIKIŞ					
4089.0Y050K.020.1	29887	Ø 50	20 cm	12	790.00
4089.0Y050K.033.1	29891	Ø 50	33 cm	12	980.00
4089.0Y050K.040.1	29895	Ø 50	40 cm	12	1070.00
4089.0Y050K.050.1	29899	Ø 50	50 cm	12	1250.00
4089.0Y050K.060.1	29903	Ø 50	60 cm	12	1406.70
4089.0Y050K.080.1	29907	Ø 50	80 cm	12	1720.00
ALT ÇIKIŞ					
4089.0A050K.020.1	29911	Ø 50	20 cm	12	790.00
4089.0A050K.033.1	29915	Ø 50	33 cm	12	980.00
4089.0A050K.040.1	29919	Ø 50	40 cm	12	1070.00
4089.0A050K.050.1	29923	Ø 50	50 cm	12	1250.00
4089.0A050K.060.1	29927	Ø 50	60 cm	12	1406.70
4089.0A050K.080.1	29931	Ø 50	80 cm	12	1720.00

Duş kanalı / W200-330-400-500-600-800 mm / Ø 50 yan - alt çıkış
Paslanmaz gövde / Paslanmaz ızgara / Sulu koku tutucu



HM-31359

Style koku tutucu kullanılmaktadır.



RAIN



KARE



BAHN



DOLU



HM-31359

Style koku tutucu kullanılmaktadır.

LEGAL FİLELİ Y360° S SIFON

Ürün Kodu	Kısa Kod	Çıkış	Ölçü		Fiyat
YAN ÇIKIŞ					
4189.FY050K.020.1	34737	Ø 50	20 cm	12	980.00
4189.FY050K.033.1	34738	Ø 50	33 cm	12	1170.00
4189.FY050K.040.1	34739	Ø 50	40 cm	12	1260.00
4189.FY050K.050.1	34740	Ø 50	50 cm	12	1440.00
4189.FY050K.060.1	34741	Ø 50	60 cm	12	1596.70
4189.FY050K.080.1	34742	Ø 50	80 cm	12	1910.00

Duş kanalı / W200-330-400-500-600-800 mm / Ø 50 yan - alt çıkış
Paslanmaz gövde / Paslanmaz ızgara / Sulu koku tutucu

LEGAL FİLELİ Y360°

Ürün Kodu	Kısa Kod	Çıkış	Ölçü		Fiyat
YAN ÇIKIŞ					
4095.FY050K.020.1	30753	Ø 50	20 cm	12	813.40
4095.FY050K.033.1	29975	Ø 50	33 cm	12	1003.40
4095.FY050K.040.1	29979	Ø 50	40 cm	12	1093.40
4095.FY050K.050.1	29983	Ø 50	50 cm	12	1270.00
4095.FY050K.060.1	29987	Ø 50	60 cm	12	1430.00
4095.FY050K.080.1	29991	Ø 50	80 cm	12	1740.00
ALT ÇIKIŞ					
4095.FA050K.020.1	30757	Ø 50	20 cm	12	813.40
4095.FA050K.033.1	29995	Ø 50	33 cm	12	1003.40
4095.FA050K.040.1	29999	Ø 50	40 cm	12	1093.40
4095.FA050K.050.1	30003	Ø 50	50 cm	12	1270.00
4095.FA050K.060.1	30007	Ø 50	60 cm	12	1430.00
4095.FA050K.080.1	30011	Ø 50	80 cm	12	1740.00

Duş kanalı / W200-330-400-500-600-800 mm / Ø 50 yan - alt çıkış
Paslanmaz gövde / Paslanmaz ızgara / Sulu koku tutucu



HM-31359

Style koku tutucu kullanılmaktadır.

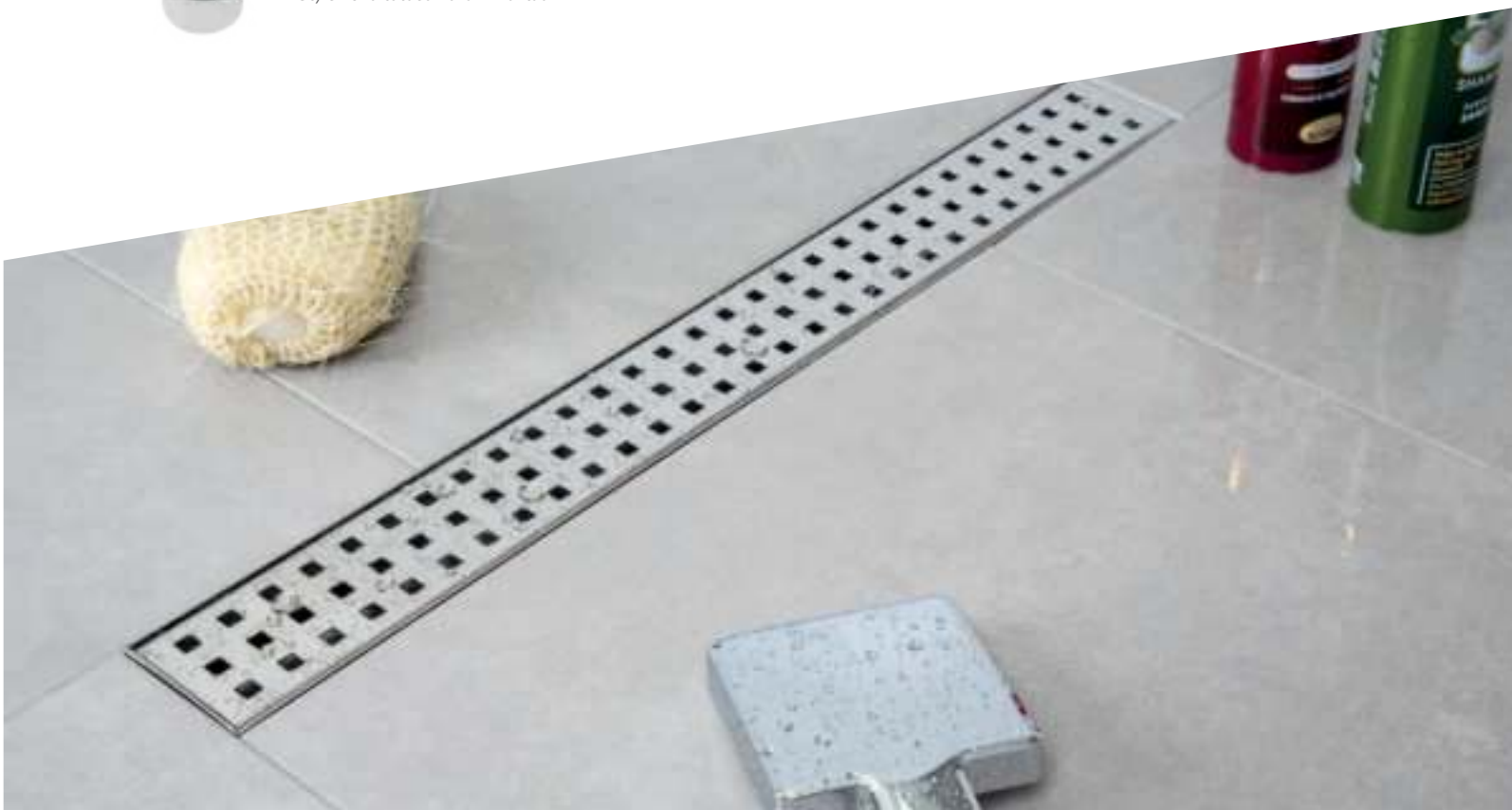

SİMPLE VEGA

Ürün Kodu	Kısa Kod	Çıkış	Ölçü		Fiyat
ALT ÇIKIŞ					
4074.0A050K.040.1	15802	Ø 50	40 cm	12	770.00
4074.0A050K.050.1	15812	Ø 50	50 cm	12	920.00
4074.0A050K.060.1	15821	Ø 50	60 cm	12	1036.70

Duş kanalı / W400-500-600 mm / Ø 50 yan - alt çıkış
Paslanmaz gövde / Paslanmaz ızgara / Sulu koku tutucu



HM-31359

Style koku tutucu kullanılmaktadır.

VEGA S SIFON

Ürün Kodu	Kısa Kod	Çıkış	Ölçü		Fiyat
YAN ÇIKIŞ					
4175.0Y050K.040.1	34743	Ø 50	40 cm	12	1076.70
4175.0Y050K.050.1	34744	Ø 50	50 cm	12	1230.00
4175.0Y050K.060.1	34745	Ø 50	60 cm	12	1350.00

Duş kanalı / W400-500-600 mm / Ø 50 yan - alt çıkış
Paslanmaz gövde / Paslanmaz ızgara / Sulu koku tutucu



HM-31359

Style koku tutucu kullanılmaktadır.

VEGA

Ürün Kodu	Kısa Kod	Çıkış	Ölçü		Fiyat
YAN ÇIKIŞ					
4075.0Y050K.040.1	15830	Ø 50	40 cm	12	873.40
4075.0Y050K.050.1	15843	Ø 50	50 cm	12	1023.40
4075.0Y050K.060.1	15858	Ø 50	60 cm	12	1143.40
ALT ÇIKIŞ					
4075.0A050K.040.1	15835	Ø 50	40 cm	12	873.40
4075.0A050K.050.1	15856	Ø 50	50 cm	12	1023.40
4075.0A050K.060.1	15871	Ø 50	60 cm	12	1143.40

Duş kanalı / W400-500-600 mm / Ø 50 yan - alt çıkış
Paslanmaz gövde / Paslanmaz ızgara / Sulu koku tutucu



HM-31359

Style koku tutucu kullanılmaktadır.



RAIN



KARE



BAHN



DOLU



HM-31359

Style koku tutucu kullanılmaktadır.

VEGA FİLELİ S SIFON

Ürün Kodu	Kısa Kod	Çıkış	Ölçü		Fiyat
YAN ÇIKIŞ					
4175.FY050K.040.1	34746	Ø 50	40 cm	12	1123.40
4175.FY050K.050.1	34747	Ø 50	50 cm	12	1276.70
4175.FY050K.060.1	34748	Ø 50	60 cm	12	1396.70

Duş kanalı / W400-500-600 mm / Ø 50 yan - alt çıkış
Paslanmaz gövde / Paslanmaz ızgara / Sulu koku tutucu



HM-31359

Style koku tutucu kullanılmaktadır.

VEGA FİLELİ

Ürün Kodu	Kısa Kod	Çıkış	Ölçü		Fiyat
YAN ÇIKIŞ					
4075.FY050K.040.1	16002	Ø 50	40 cm	12	953.40
4075.FY050K.050.1	16011	Ø 50	50 cm	12	1106.70
4075.FY050K.060.1	16020	Ø 50	60 cm	12	1226.70
ALT ÇIKIŞ					
4075.FA050K.040.1	16031	Ø 50	40 cm	12	953.40
4075.FA050K.050.1	16051	Ø 50	50 cm	12	1106.70
4075.FA050K.060.1	16066	Ø 50	60 cm	12	1226.70

Duş kanalı / W400-500-600 mm / Ø 50 yan - alt çıkış
Paslanmaz gövde / Paslanmaz ızgara / Sulu koku tutucu



VEGA SİFONİK

Ürün Kodu	Kısa Kod	Çıkış	Ölçü	Fiyat
YAN ÇIKIŞ				
4076.0Y050K.040.1	15882	Ø 50	40 cm	853.40
4076.0Y050K.050.1	15911	Ø 50	50 cm	1006.70
4076.0Y050K.060.1	15925	Ø 50	60 cm	1123.40

Duş kanalı / W400-500-600 mm / Ø 50 yan - alt çıkış
Paslanmaz gövde / Paslanmaz ızgara / Sulu koku tutucu



HM-31359

Style koku tutucu kullanılmaktadır.

VEGA Y360° S SİFON

Ürün Kodu	Kısa Kod	Çıkış	Ölçü	Fiyat
YAN ÇIKIŞ				
4170.0Y050K.040.1	34749	Ø 50	40 cm	1163.40
4170.0Y050K.050.1	34750	Ø 50	50 cm	1316.70
4170.0Y050K.060.1	34751	Ø 50	60 cm	1436.70

Duş kanalı / W400-500-600 mm / Ø 50 yan - alt çıkış
Paslanmaz gövde / Paslanmaz ızgara / Sulu koku tutucu



HM-31359

Style koku tutucu kullanılmaktadır.

VEGA Y360°

Ürün Kodu	Kısa Kod	Çıkış	Ölçü	Fiyat
YAN ÇIKIŞ				
4070.0Y050K.040.1	30025	Ø 50	40 cm	996.70
4070.0Y050K.050.1	30029	Ø 50	50 cm	1150.00
4070.0Y050K.060.1	30033	Ø 50	60 cm	1270.00
ALT ÇIKIŞ				
4070.0A050K.040.1	30037	Ø 50	40 cm	996.70
4070.0A050K.050.1	30041	Ø 50	50 cm	1150.00
4070.0A050K.060.1	30045	Ø 50	60 cm	1270.00

Duş kanalı / W400-500-600 mm / Ø 50 yan - alt çıkış
Paslanmaz gövde / Paslanmaz ızgara / Sulu koku tutucu



HM-31359

Style koku tutucu kullanılmaktadır.



RAIN



KARE



BAHN



DOLU



HM-31359

Style koku tutucu kullanılmaktadır.

VEGA FİLELİ Y360° S SIFON

Ürün Kodu	Kısa Kod	Çıkış	Ölçü		Fiyat
YAN ÇIKIŞ					
4170.FY050K.040.1	34752	Ø 50	40 cm	12	1186.70
4170.FY050K.050.1	34753	Ø 50	50 cm	12	1340.00
4170.FY050K.060.1	34754	Ø 50	60 cm	12	1460.00

Duş kanalı / W400-500-600 mm / Ø 50 yan - alt çıkış
Paslanmaz gövde / Paslanmaz ızgara / Sulu koku tutucu

VEGA FİLELİ Y360°

Ürün Kodu	Kısa Kod	Çıkış	Ölçü		Fiyat
YAN ÇIKIŞ					
4069.FY050K.040.1	30073	Ø 50	40 cm	12	1020.00
4069.FY050K.050.1	30077	Ø 50	50 cm	12	1173.40
4069.FY050K.060.1	30081	Ø 50	60 cm	12	1293.40
ALT ÇIKIŞ					
4069.FA050K.040.1	30085	Ø 50	40 cm	12	1020.00
4069.FA050K.050.1	30089	Ø 50	50 cm	12	1173.40
4069.FA050K.060.1	30093	Ø 50	60 cm	12	1293.40

Duş kanalı / W400-500-600 mm / Ø 50 yan - alt çıkış
Paslanmaz gövde / Paslanmaz ızgara / Sulu koku tutucu



HM-31359

Style koku tutucu kullanılmaktadır.



SİMPLE VEGA LUX

Ürün Kodu	Kısa Kod	Çıkış	Ölçü		Fiyat
ALT ÇIKIŞ					
4077.0A050K.040.1	15886	Ø 50	40 cm	12	923.40
4077.0A050K.050.1	15901	Ø 50	50 cm	12	1066.70
4077.0A050K.060.1	15917	Ø 50	60 cm	12	1203.40

Duş kanalı / W400-500-600 mm / Ø 50 yan - alt çıkış
Paslanmaz gövde / Paslanmaz çerçeve ve ızgara / Sulu koku tutucu



HM-31359

Style koku tutucu kullanılmaktadır.

VEGA LUX S SIFON

Ürün Kodu	Kısa Kod	Çıkış	Ölçü		Fiyat
ALT ÇIKIŞ					
4178.0Y050K.040.1	34755	Ø 50	40 cm	12	1203.40
4178.0Y050K.050.1	34756	Ø 50	50 cm	12	1350.00
4178.0Y050K.060.1	34757	Ø 50	60 cm	12	1486.70

Duş kanalı / W400-500-600 mm / Ø 50 yan - alt çıkış
Paslanmaz gövde / Paslanmaz çerçeve ve ızgara / Sulu koku tutucu



HM-31359

Style koku tutucu kullanılmaktadır.

VEGA LUX

Ürün Kodu	Kısa Kod	Çıkış	Ölçü		Fiyat
YAN ÇIKIŞ					
4078.0Y050K.040.1	15935	Ø 50	40 cm	12	1033.40
4078.0Y050K.050.1	15952	Ø 50	50 cm	12	1180.00
4078.0Y050K.060.1	15961	Ø 50	60 cm	12	1313.40
ALT ÇIKIŞ					
4078.0A050K.040.1	15943	Ø 50	40 cm	12	1033.40
4078.0A050K.050.1	16046	Ø 50	50 cm	12	1180.00
4078.0A050K.060.1	16071	Ø 50	60 cm	12	1313.40

Duş kanalı / W400-500-600 mm / Ø 50 yan - alt çıkış
Paslanmaz gövde / Paslanmaz çerçeve ve ızgara / Sulu koku tutucu



HM-31359

Style koku tutucu kullanılmaktadır.



RAIN



KARE



BAHN



DOLU

New



HM-31359

Style koku tutucu kullanılmaktadır.

VEGA LUX FİLELİ S SİFON

Ürün Kodu	Kısa Kod	Çıkış	Ölçü	Fiyat
ALT ÇIKIŞ				
4178.FY050K.040.1	34758	Ø 50	40 cm	1250.00
4178.FY050K.050.1	34759	Ø 50	50 cm	1396.70
4178.FY050K.060.1	34760	Ø 50	60 cm	1533.40

Duş kanalı / W400-500-600 mm / Ø 50 yan - alt çıkış
Paslanmaz gövde / Paslanmaz çerçeve ve ızgara / Sulu koku tutucu



HM-31359

Style koku tutucu kullanılmaktadır.

VEGA LUX FİLELİ

Ürün Kodu	Kısa Kod	Çıkış	Ölçü	Fiyat
YAN ÇIKIŞ				
4078.FY050K.040.1	16083	Ø 50	40 cm	1080.00
4078.FY050K.050.1	16094	Ø 50	50 cm	1226.70
4078.FY050K.060.1	16117	Ø 50	60 cm	1366.70
ALT ÇIKIŞ				
4078.FA050K.040.1	16086	Ø 50	40 cm	1080.00
4078.FA050K.050.1	16109	Ø 50	50 cm	1226.70
4078.FA050K.060.1	16143	Ø 50	60 cm	1366.70

Duş kanalı / W400-500-600 mm / Ø 50 yan - alt çıkış
Paslanmaz gövde / Paslanmaz çerçeve ve ızgara / Sulu koku tutucu



VEGA LUX SİFONİK

Ürün Kodu	Kısa Kod	Çıkış	Ölçü	Fiyat
YAN ÇIKIŞ				
4079.0Y050K.040.1	15971	Ø 50	40 cm	12 1013.40
4079.0Y050K.050.1	15981	Ø 50	50 cm	12 1160.00
4079.0Y050K.060.1	15991	Ø 50	60 cm	12 1293.40

Duş kanalı / W400-500-600 mm / Ø 50 yan - alt çıkış
Paslanmaz gövde / Paslanmaz çerçeve ve ızgara / Sulu koku tutucu



HM-31359

Style koku tutucu kullanılmaktadır.

VEGA LUX Y360° S SİFON

Ürün Kodu	Kısa Kod	Çıkış	Ölçü	Fiyat
YAN ÇIKIŞ				
4171.0Y050K.040.1	34761	Ø 50	40 cm	12 1290.00
4171.0Y050K.050.1	34762	Ø 50	50 cm	12 1436.70
4171.0Y050K.060.1	34763	Ø 50	60 cm	12 1576.70

Duş kanalı / W400-500-600 mm / Ø 50 yan - alt çıkış
Paslanmaz gövde / Paslanmaz çerçeve ve ızgara / Sulu koku tutucu



HM-31359

Style koku tutucu kullanılmaktadır.

VEGA LUX Y360°

Ürün Kodu	Kısa Kod	Çıkış	Ölçü	Fiyat
YAN ÇIKIŞ				
4071.0Y050K.040.1	30049	Ø 50	40 cm	12 1123.40
4071.0Y050K.050.1	30053	Ø 50	50 cm	12 1270.00
4071.0Y050K.060.1	30057	Ø 50	60 cm	12 1406.70
ALT ÇIKIŞ				
4071.0A050K.040.1	30061	Ø 50	40 cm	12 1123.40
4071.0A050K.050.1	30065	Ø 50	50 cm	12 1270.00
4071.0A050K.060.1	30069	Ø 50	60 cm	12 1406.70

Duş kanalı / W400-500-600 mm / Ø 50 yan - alt çıkış
Paslanmaz gövde / Paslanmaz çerçeve ve ızgara / Sulu koku tutucu



HM-31359

Style koku tutucu kullanılmaktadır.



RAIN



KARE



BAHN



DOLU



HM-31359

Style koku tutucu kullanılmaktadır.

VEGA LUX FİLELİ Y360° S SİFON

Ürün Kodu	Kısa Kod	Çıkış	Ölçü	Fiyat
YAN ÇIKIŞ				
4171.FY050K.040.1	34764	Ø 50	40 cm	12 1313.40
4171.FY050K.050.1	34765	Ø 50	50 cm	12 1460.00
4171.FY050K.060.1	34766	Ø 50	60 cm	12 1596.70

*Duş kanalı / W400-500-600 mm / Ø 50 yan - alt çıkış
Paslanmaz gövde / Paslanmaz çerçeve ve ızgara / Sulu koku tutucu*

VEGA LUX FİLELİ Y360°

Ürün Kodu	Kısa Kod	Çıkış	Ölçü	Fiyat
YAN ÇIKIŞ				
4068.FY050K.040.1	30792	Ø 50	40 cm	12 1146.70
4068.FY050K.050.1	30796	Ø 50	50 cm	12 1293.40
4068.FY050K.060.1	30800	Ø 50	60 cm	12 1430.00
ALT ÇIKIŞ				
4068.FA050K.040.1	30804	Ø 50	40 cm	12 1146.70
4068.FA050K.050.1	30808	Ø 50	50 cm	12 1293.40
4068.FA050K.060.1	30812	Ø 50	60 cm	12 1430.00

*Duş kanalı / W400-500-600 mm / Ø 50 yan - alt çıkış
Paslanmaz gövde / Paslanmaz çerçeve ve ızgara / Sulu koku tutucu*



HM-31359

Style koku tutucu kullanılmaktadır.



SİMPLE ALFA

Ürün Kodu	Kısa Kod	Çıkış	Ölçü		Fiyat
ALT ÇIKIŞ					
4060.0A050K.020.1	29724	Ø 50	20 cm	12	636.70
4060.0A050K.030.1	29726	Ø 50	30 cm	12	796.70
4060.0A050K.040.1	28913	Ø 50	40 cm	12	946.70
4060.0A050K.050.1	28914	Ø 50	50 cm	12	1136.70
4060.0A050K.060.1	28915	Ø 50	60 cm	12	1286.70

Duş kanalı / W200-330-400-500-600 mm / Ø 50 yan - alt çıkış
Paslanmaz gövde / Paslanmaz ızgara / Sulu koku tutucu



HM-31359

Style koku tutucu kullanılmaktadır.

ALFA S SİFON

Ürün Kodu	Kısa Kod	Çıkış	Ölçü		Fiyat
YAN ÇIKIŞ					
4160.0Y050K.020.1	34767	Ø 50	20 cm	12	930.00
4160.0Y050K.030.1	34768	Ø 50	30 cm	12	1086.70
4160.0Y050K.040.1	34769	Ø 50	40 cm	12	1226.70
4160.0Y050K.050.1	34770	Ø 50	50 cm	12	1416.70
4160.0Y050K.060.1	34771	Ø 50	60 cm	12	1563.40

Duş kanalı / W200-330-400-500-600 mm / Ø 50 yan - alt çıkış
Paslanmaz gövde / Paslanmaz ızgara / Sulu koku tutucu



HM-31359

Style koku tutucu kullanılmaktadır.

ALFA

Ürün Kodu	Kısa Kod	Çıkış	Ölçü		Fiyat
YAN ÇIKIŞ					
4060.0Y050K.020.1	29723	Ø 50	20 cm	12	733.40
4060.0Y050K.030.1	29725	Ø 50	30 cm	12	896.70
4060.0Y050K.040.1	28919	Ø 50	40 cm	12	1043.40
4060.0Y050K.050.1	28920	Ø 50	50 cm	12	1236.70
4060.0Y050K.060.1	28921	Ø 50	60 cm	12	1386.70
ALT ÇIKIŞ					
4067.0A050K.020.1	31372	Ø 50	20 cm	12	733.40
4067.0A050K.030.1	31373	Ø 50	30 cm	12	896.70
4067.0A050K.040.1	31374	Ø 50	40 cm	12	1043.40
4067.0A050K.050.1	31375	Ø 50	50 cm	12	1236.70
4067.0A050K.060.1	31376	Ø 50	60 cm	12	1386.70

Duş kanalı / W200-330-400-500-600 mm / Ø 50 yan - alt çıkış
Paslanmaz gövde / Paslanmaz ızgara / Sulu koku tutucu



HM-31359

Style koku tutucu kullanılmaktadır.



RAIN



KARE



BAHN



DOLU

New



HM-31359

Style koku tutucu kullanılmaktadır.

ALFA Y360° S SIFON

Ürün Kodu	Kısa Kod	Çıkış	Ölçü		Fiyat
YAN ÇIKIŞ					
4164.0Y050K.020.1	34772	Ø 50	20 cm	12	1016.70
4164.0Y050K.030.1	34773	Ø 50	30 cm	12	1176.70
4164.0Y050K.040.1	34774	Ø 50	40 cm	12	1313.40
4164.0Y050K.050.1	34775	Ø 50	50 cm	12	1506.70
4164.0Y050K.060.1	34776	Ø 50	60 cm	12	1650.00

Duş kanalı / W200-330-400-500-600 mm / Ø 50 yan - alt çıkış
Paslanmaz gövde / Paslanmaz ızgara / Sulu koku tutucu



HM-31359

Style koku tutucu kullanılmaktadır.

ALFA Y360°

Ürün Kodu	Kısa Kod	Çıkış	Ölçü		Fiyat
YAN ÇIKIŞ					
4064.0Y050K.020.1	30015	Ø 50	20 cm	12	850.00
4064.0Y050K.030.1	30016	Ø 50	30 cm	12	1006.70
4064.0Y050K.040.1	30017	Ø 50	40 cm	12	1153.40
4064.0Y050K.050.1	30018	Ø 50	50 cm	12	1346.70
4064.0Y050K.060.1	30019	Ø 50	60 cm	12	1490.00
ALT ÇIKIŞ					
4064.0A050K.020.1	30761	Ø 50	20 cm	12	850.00
4064.0A050K.030.1	30762	Ø 50	30 cm	12	1006.70
4064.0A050K.040.1	30763	Ø 50	40 cm	12	1153.40
4064.0A050K.050.1	30764	Ø 50	50 cm	12	1346.70
4064.0A050K.060.1	30765	Ø 50	60 cm	12	1490.00

Duş kanalı / W200-330-400-500-600 mm / Ø 50 yan - alt çıkış
Paslanmaz gövde / Paslanmaz ızgara / Sulu koku tutucu



SİMPLE DELUXE

Ürün Kodu	Kısa Kod	Çıkış	Ölçü		Fiyat
ALT ÇIKIŞ					
4061.0A050K.020.1	29728	Ø 50	20 cm	12	643.40
4061.0A050K.030.1	29730	Ø 50	30 cm	12	806.70
4061.0A050K.040.1	28916	Ø 50	40 cm	12	953.40
4061.0A050K.050.1	28917	Ø 50	50 cm	12	1153.40
4061.0A050K.060.1	28918	Ø 50	60 cm	12	1303.40

Duş kanalı / W200-330-400-500-600-800 mm / Ø 50 yan - alt çıkış
Paslanmaz gövde / Paslanmaz ızgara / Sulu koku tutucu



HM-31359

Style koku tutucu kullanılmaktadır.

DELUXE S SİFON

Ürün Kodu	Kısa Kod	Çıkış	Ölçü		Fiyat
YAN ÇIKIŞ					
4161.0Y050K.020.1	34777	Ø 50	20 cm	12	936.70
4161.0Y050K.030.1	34778	Ø 50	30 cm	12	1093.40
4161.0Y050K.040.1	34779	Ø 50	40 cm	12	1233.40
4161.0Y050K.050.1	34780	Ø 50	50 cm	12	1433.40
4161.0Y050K.060.1	34781	Ø 50	60 cm	12	1576.70

Duş kanalı / W200-330-400-500-600-800 mm / Ø 50 yan - alt çıkış
Paslanmaz gövde / Paslanmaz ızgara / Sulu koku tutucu



HM-31359

Style koku tutucu kullanılmaktadır.

DELUXE

Ürün Kodu	Kısa Kod	Çıkış	Ölçü		Fiyat
YAN ÇIKIŞ					
4061.0Y050K.020.1	29727	Ø 50	20 cm	12	743.40
4061.0Y050K.030.1	29729	Ø 50	30 cm	12	906.70
4061.0Y050K.040.1	28922	Ø 50	40 cm	12	1053.40
4061.0Y050K.050.1	28923	Ø 50	50 cm	12	1253.40
4061.0Y050K.060.1	28924	Ø 50	60 cm	12	1403.40
ALT ÇIKIŞ					
4065.0A050K.020.1	31377	Ø 50	20 cm	12	743.40
4065.0A050K.030.1	31378	Ø 50	30 cm	12	906.70
4065.0A050K.040.1	31379	Ø 50	40 cm	12	1053.40
4065.0A050K.050.1	31380	Ø 50	50 cm	12	1253.40
4065.0A050K.060.1	31381	Ø 50	60 cm	12	1403.40

Duş kanalı / W200-330-400-500-600-800 mm / Ø 50 yan - alt çıkış
Paslanmaz gövde / Paslanmaz ızgara / Sulu koku tutucu



HM-31359

Style koku tutucu kullanılmaktadır.



HM-31359

Style koku tutucu kullanılmaktadır.

DELUXE Y360° S SIFON

Ürün Kodu	Kısa Kod	Çıkış	Ölçü		Fiyat
YAN ÇIKIŞ					
4166.0Y050K.020.1	34782	Ø 50	20 cm	12	1026.70
4166.0Y050K.030.1	34783	Ø 50	30 cm	12	1183.40
4166.0Y050K.040.1	34784	Ø 50	40 cm	12	1323.40
4166.0Y050K.050.1	34785	Ø 50	50 cm	12	1520.00
4166.0Y050K.060.1	34786	Ø 50	60 cm	12	1666.70

Duş kanalı / W200-330-400-500-600-800 mm / Ø 50 yan - alt çıkış
Paslanmaz gövde / Paslanmaz ızgara / Sulu koku tutucu

DELUXE Y360°

Ürün Kodu	Kısa Kod	Çıkış	Ölçü		Fiyat
YAN ÇIKIŞ					
4066.0Y050K.020.1	30020	Ø 50	20 cm	12	856.70
4066.0Y050K.030.1	30021	Ø 50	30 cm	12	1016.70
4066.0Y050K.040.1	30022	Ø 50	40 cm	12	1156.70
4066.0Y050K.050.1	30023	Ø 50	50 cm	12	1353.40
4066.0Y050K.060.1	30024	Ø 50	60 cm	12	1500.00
ALT ÇIKIŞ					
4066.0A050K.020.1	30766	Ø 50	20 cm	12	856.70
4066.0A050K.030.1	30767	Ø 50	30 cm	12	1016.70
4066.0A050K.040.1	30768	Ø 50	40 cm	12	1156.70
4066.0A050K.050.1	30769	Ø 50	50 cm	12	1353.40
4066.0A050K.060.1	30770	Ø 50	60 cm	12	1500.00

Duş kanalı / W200-330-400-500-600-800 mm / Ø 50 yan - alt çıkış
Paslanmaz gövde / Paslanmaz ızgara / Sulu koku tutucu



HM-31359

Style koku tutucu kullanılmaktadır.



LINE S SIFON

Ürün Kodu	Kısa Kod	Çıkış	Ölçü	Fiyat
YAN ÇIKIŞ				
3252.0Y050K.033.1	34787	Ø 50	30 cm	683.40
3252.0Y050K.040.1	34788	Ø 50	40 cm	740.00
3252.0Y050K.050.1	34789	Ø 50	50 cm	846.70
3252.0Y050K.060.1	34790	Ø 50	60 cm	910.00
3252.0Y050K.080.1	34791	Ø 50	80 cm	1053.40

Duş kanalı / W300-400-500-600-800 mm / Ø 50 yan - alt çıkış
Plastik gövde / Paslanmaz ızgara / Sulu koku tutucu



3253.0Y050K



3254.0Y050K

LINE

Ürün Kodu	Kısa Kod	Çıkış	Ölçü	Fiyat
YAN ÇIKIŞ				
3152.0Y050K.033.1	26499	Ø 50	30 cm	480.00
3152.0Y050K.040.1	26500	Ø 50	40 cm	540.00
3152.0Y050K.050.1	26501	Ø 50	50 cm	643.40
3152.0Y050K.060.1	26502	Ø 50	60 cm	706.70
3152.0Y050K.080.1	26503	Ø 50	80 cm	823.40
ALT ÇIKIŞ				
3152.0A050K.033.1	26494	Ø 50	30 cm	480.00
3152.0A050K.040.1	26495	Ø 50	40 cm	540.00
3152.0A050K.050.1	26496	Ø 50	50 cm	643.40
3152.0A050K.060.1	26497	Ø 50	60 cm	706.70
3152.0A050K.080.1	26498	Ø 50	80 cm	823.40

Duş kanalı / W300-400-500-600-800 mm / Ø 50 yan - alt çıkış
Plastik gövde / Paslanmaz ızgara / Sulu koku tutucu



3152.0Y050K



3154.0Y050K

New



HM-27970

Pera koku tutucu kullanılmaktadır.



HM-27970

Pera koku tutucu kullanılmaktadır.

New



HM-27970

Pera koku tutucu kullanılmaktadır.

LINE Y360° S SIFON

Ürün Kodu	Kısa Kod	Çıkış	Ölçü	Fiyat
YAN ÇIKIŞ				
3250.0Y050K.033.1	34792	Ø 50	30 cm	770.00
3250.0Y050K.040.1	34793	Ø 50	40 cm	826.70
3250.0Y050K.050.1	34794	Ø 50	50 cm	933.40
3250.0Y050K.060.1	34795	Ø 50	60 cm	996.70
3250.0Y050K.080.1	34796	Ø 50	80 cm	1140.00

Duş kanalı / W300-400-500-600-800 mm / Ø 50 yan - alt çıkış
Plastik gövde / Paslanmaz ızgara / Sulu koku tutucu



3251.0Y050K



3249.0Y050K



HM-27970

Pera koku tutucu kullanılmaktadır.

LINE Y360°

Ürün Kodu	Kısa Kod	Çıkış	Ölçü	Fiyat
YAN ÇIKIŞ				
3150.0Y050K.033.1	30097	Ø 50	30 cm	606.70
3150.0Y050K.040.1	30098	Ø 50	40 cm	663.40
3150.0Y050K.050.1	30099	Ø 50	50 cm	770.00
3150.0Y050K.060.1	30100	Ø 50	60 cm	836.70
3150.0Y050K.080.1	30101	Ø 50	80 cm	980.00
ALT ÇIKIŞ				
3150.0A050K.033.1	30102	Ø 50	30 cm	606.70
3150.0A050K.040.1	30103	Ø 50	40 cm	663.40
3150.0A050K.050.1	30104	Ø 50	50 cm	770.00
3150.0A050K.060.1	30105	Ø 50	60 cm	836.70
3150.0A050K.080.1	30106	Ø 50	80 cm	980.00

Duş kanalı / W300-400-500-600-800 mm / Ø 50 yan - alt çıkış
Plastik gövde / Paslanmaz ızgara / Sulu koku tutucu



3151.0Y050K



3149.0Y050K

LINE S SIFON

Ürün Kodu	Kısa Kod	Çıkış	Ölçü	İkili	Fiyat
YAN ÇIKIŞ					
3255.0Y050K.033.1	34797	Ø 50	30 cm	12	700.00
3255.0Y050K.040.1	34798	Ø 50	40 cm	12	766.70
3255.0Y050K.050.1	34799	Ø 50	50 cm	12	870.00
3255.0Y050K.060.1	34800	Ø 50	60 cm	12	940.00
3255.0Y050K.080.1	34801	Ø 50	80 cm	12	1090.00

Duş kanalı / W300-400-500-600-800 mm / Ø 50 yan - alt çıkış
Plastik gövde / Paslanmaz ızgara / Sulu koku tutucu

New



HM-27970

Pera koku tutucu kullanılmaktadır.



3256.0Y050K



3257.0Y050K

LINE

Ürün Kodu	Kısa Kod	Çıkış	Ölçü	İkili	Fiyat
YAN ÇIKIŞ					
3155.0Y050K.033.1	26529	Ø 50	30 cm	12	520.00
3155.0Y050K.040.1	26530	Ø 50	40 cm	12	586.70
3155.0Y050K.050.1	26531	Ø 50	50 cm	12	690.00
3155.0Y050K.060.1	26532	Ø 50	60 cm	12	753.40
3155.0Y050K.080.1	26533	Ø 50	80 cm	12	896.70
ALT ÇIKIŞ					
3155.0A050K.033.1	26524	Ø 50	30 cm	12	520.00
3155.0A050K.040.1	26525	Ø 50	40 cm	12	586.70
3155.0A050K.050.1	26526	Ø 50	50 cm	12	690.00
3155.0A050K.060.1	26527	Ø 50	60 cm	12	753.40
3155.0A050K.080.1	26528	Ø 50	80 cm	12	896.70

Duş kanalı / W300-400-500-600-800 mm / Ø 50 yan - alt çıkış
Plastik gövde / Paslanmaz ızgara / Sulu koku tutucu



HM-27970

Pera koku tutucu kullanılmaktadır.



3156.0Y050K



3157.0Y050K



HM-27970

Pera koku tutucu kullanılmaktadır.

LINE Y360° S SIFON

Ürün Kodu	Kısa Kod	Çıkış	Ölçü	İkili	Fiyat
YAN ÇIKIŞ					
3248.0Y050K.033.1	34802	Ø 50	30 cm	12	786.70
3248.0Y050K.040.1	34803	Ø 50	40 cm	12	850.00
3248.0Y050K.050.1	34804	Ø 50	50 cm	12	956.70
3248.0Y050K.060.1	34805	Ø 50	60 cm	12	1026.70
3248.0Y050K.080.1	34806	Ø 50	80 cm	12	1176.70

Duş kanalı / W300-400-500-600-800 mm / Ø 50 yan - alt çıkış
Plastik gövde / Paslanmaz ızgara / Sulu koku tutucu



3246.0Y050K



3260.0Y050K

LINE Y360°

Ürün Kodu	Kısa Kod	Çıkış	Ölçü	İkili	Fiyat
YAN ÇIKIŞ					
3148.0Y050K.033.1	30127	Ø 50	30 cm	12	623.40
3148.0Y050K.040.1	30128	Ø 50	40 cm	12	690.00
3148.0Y050K.050.1	30129	Ø 50	50 cm	12	796.70
3148.0Y050K.060.1	30130	Ø 50	60 cm	12	863.40
3148.0Y050K.080.1	30131	Ø 50	80 cm	12	1016.70
ALT ÇIKIŞ					
3148.0A050K.033.1	30132	Ø 50	30 cm	12	623.40
3148.0A050K.040.1	30133	Ø 50	40 cm	12	690.00
3148.0A050K.050.1	30134	Ø 50	50 cm	12	796.70
3148.0A050K.060.1	30135	Ø 50	60 cm	12	863.40
3148.0A050K.080.1	30136	Ø 50	80 cm	12	1016.70

Duş kanalı / W300-400-500-600-800 mm / Ø 50 yan - alt çıkış
Plastik gövde / Paslanmaz ızgara / Sulu koku tutucu



HM-27970

Pera koku tutucu kullanılmaktadır.



3146.0Y050K



3160.0Y050K

LINE T.M.

Ürün Kodu	Kısa Kod	Çıkış	Ölçü		Fiyat
YAN ÇIKIŞ					
3155.TY050K.033.1	26539	Ø 50	30 cm	12	620.00
3155.TY050K.040.1	26540	Ø 50	40 cm	12	696.70
3155.TY050K.050.1	26541	Ø 50	50 cm	12	816.70
3155.TY050K.060.1	26542	Ø 50	60 cm	12	896.70
3155.TY050K.080.1	26543	Ø 50	80 cm	12	1053.40

ALT ÇIKIŞ

3155.TA050K.033.1	26534	Ø 50	30 cm	12	620.00
3155.TA050K.040.1	26535	Ø 50	40 cm	12	696.70
3155.TA050K.050.1	26536	Ø 50	50 cm	12	816.70
3155.TA050K.060.1	26537	Ø 50	60 cm	12	896.70
3155.TA050K.080.1	26538	Ø 50	80 cm	12	1053.40

Duş kanalı / W300-400-500-600-800 mm / Ø 50 yan - alt çıkış
Plastik gövde / Paslanmaz ızgara / Sulu koku tutucu



3156.TY050K



3157.TY050K



HM-27970

Pera koku tutucu kullanılmaktadır.

LINE T.M. Y360°

Ürün Kodu	Kısa Kod	Çıkış	Ölçü		Fiyat
YAN ÇIKIŞ					
3168.TY050K.033.1	30207	Ø 50	30 cm	12	726.70
3168.TY050K.040.1	30208	Ø 50	40 cm	12	800.00
3168.TY050K.050.1	30209	Ø 50	50 cm	12	923.40
3168.TY050K.060.1	30210	Ø 50	60 cm	12	1006.70
3168.TY050K.080.1	30211	Ø 50	80 cm	12	1173.40

ALT ÇIKIŞ

3168.TA050K.033.1	30212	Ø 50	30 cm	12	726.70
3168.TA050K.040.1	30213	Ø 50	40 cm	12	800.00
3168.TA050K.050.1	30214	Ø 50	50 cm	12	923.40
3168.TA050K.060.1	30215	Ø 50	60 cm	12	1006.70
3168.TA050K.080.1	30216	Ø 50	80 cm	12	1173.40

Duş kanalı / W300-400-500-600-800 mm / Ø 50 yan - alt çıkış
Plastik gövde / Paslanmaz ızgara / Sulu koku tutucu



3169.TY050K



3170.TY050K



HM-27970

Pera koku tutucu kullanılmaktadır.



HM-27970

Pera koku tutucu kullanılmaktadır.

LEGAL SİFON

Ürün Kodu	Kısa Kod	Çıkış	Ölçü		Fiyat
YAN ÇIKIŞ					
3258.0Y050K.033.1	34807	Ø 50	30 cm	12	1030.00
3258.0Y050K.040.1	34808	Ø 50	40 cm	12	1160.00
3258.0Y050K.050.1	34809	Ø 50	50 cm	12	1426.70
3258.0Y050K.060.1	34810	Ø 50	60 cm	12	1573.40
3258.0Y050K.080.1	34811	Ø 50	80 cm	12	1856.70

Duş kanalı / W300-400-500-600-800 mm / Ø 50 yan - alt çıkış
Plastik gövde / Paslanmaz ızgara ve kasa / Sulu koku tutucu



3259.0Y050K

LEGAL

Ürün Kodu	Kısa Kod	Çıkış	Ölçü		Fiyat
YAN ÇIKIŞ					
3158.0Y050K.033.1	26595	Ø 50	30 cm	12	846.70
3158.0Y050K.040.1	26596	Ø 50	40 cm	12	980.00
3158.0Y050K.050.1	26597	Ø 50	50 cm	12	1243.40
3158.0Y050K.060.1	26598	Ø 50	60 cm	12	1386.70
3158.0Y050K.080.1	26599	Ø 50	80 cm	12	1663.40

ALT ÇIKIŞ

3158.0A050K.033.1	26587	Ø 50	30 cm	12	846.70
3158.0A050K.040.1	26588	Ø 50	40 cm	12	980.00
3158.0A050K.050.1	26592	Ø 50	50 cm	12	1243.40
3158.0A050K.060.1	26593	Ø 50	60 cm	12	1386.70
3158.0A050K.080.1	26594	Ø 50	80 cm	12	1663.40

Duş kanalı / W300-400-500-600-800 mm / Ø 50 yan - alt çıkış
Plastik gövde / Paslanmaz ızgara ve kasa / Sulu koku tutucu



HM-27970

Pera koku tutucu kullanılmaktadır.



3159.0Y050K

LEGAL Y360° S SİFON

Ürün Kodu	Kısa Kod	Çıkış	Ölçü	İkili	Fiyat
YAN ÇIKIŞ					
3261.0Y050K.033.1	34812	Ø 50	30 cm	12	1120.00
3261.0Y050K.040.1	34813	Ø 50	40 cm	12	1253.40
3261.0Y050K.050.1	34814	Ø 50	50 cm	12	1520.00
3261.0Y050K.060.1	34815	Ø 50	60 cm	12	1670.00
3261.0Y050K.080.1	34816	Ø 50	80 cm	12	1950.00

Duş kanalı / W300-400-500-600-800 mm / Ø 50 yan - alt çıkış
Plastik gövde / Paslanmaz ızgara ve kasa / Sulu koku tutucu



3267.0Y050K



HM-27970

Pera koku tutucu kullanılmaktadır.

LEGAL Y360°

Ürün Kodu	Kısa Kod	Çıkış	Ölçü	İkili	Fiyat
YAN ÇIKIŞ					
3161.0Y050K.033.1	30167	Ø 50	30 cm	12	960.00
3161.0Y050K.040.1	30168	Ø 50	40 cm	12	1090.00
3161.0Y050K.050.1	30169	Ø 50	50 cm	12	1360.00
3161.0Y050K.060.1	30170	Ø 50	60 cm	12	1506.70
3161.0Y050K.080.1	30171	Ø 50	80 cm	12	1790.00

ALT ÇIKIŞ

3161.0A050K.033.1	30172	Ø 50	30 cm	12	960.00
3161.0A050K.040.1	30173	Ø 50	40 cm	12	1090.00
3161.0A050K.050.1	30174	Ø 50	50 cm	12	1360.00
3161.0A050K.060.1	30175	Ø 50	60 cm	12	1506.70
3161.0A050K.080.1	30176	Ø 50	80 cm	12	1790.00

Duş kanalı / W300-400-500-600-800 mm / Ø 50 yan - alt çıkış
Plastik gövde / Paslanmaz ızgara ve kasa / Sulu koku tutucu



3167.0Y050K



HM-27970

Pera koku tutucu kullanılmaktadır.



HM-27970

Pera koku tutucu kullanılmaktadır.

LEGAL T.M.

Ürün Kodu	Kısa Kod	Çıkış	Ölçü		Fiyat
YAN ÇIKIŞ					
3158.TY050K.033.1	26604	Ø 50	30 cm	12	953.40
3158.TY050K.040.1	26605	Ø 50	40 cm	12	1096.70
3158.TY050K.050.1	26606	Ø 50	50 cm	12	1376.70
3158.TY050K.060.1	26607	Ø 50	60 cm	12	1536.70
3158.TY050K.080.1	26608	Ø 50	80 cm	12	1826.70
ALT ÇIKIŞ					
3158.TA050K.033.1	26609	Ø 50	30 cm	12	953.40
3158.TA050K.040.1	26600	Ø 50	40 cm	12	1096.70
3158.TA050K.050.1	26601	Ø 50	50 cm	12	1376.70
3158.TA050K.060.1	26602	Ø 50	60 cm	12	1536.70
3158.TA050K.080.1	26603	Ø 50	80 cm	12	1826.70

Duş kanalı / W300-400-500-600-800 mm / Ø 50 yan - alt çıkış
Plastik gövde / Paslanmaz ızgara ve kasa / Sulu koku tutucu



3159.TY050K

LINE FİLELİ

Ürün Kodu	Kısa Kod	Çıkış	Ölçü		Fiyat
YAN ÇIKIŞ					
3155.FY050K.033.1	27366	Ø 50	30 cm	12	563.40
3155.FY050K.040.1	27367	Ø 50	40 cm	12	653.40
3155.FY050K.050.1	27368	Ø 50	50 cm	12	760.00
3155.FY050K.060.1	27369	Ø 50	60 cm	12	823.40
3155.FY050K.080.1	27370	Ø 50	80 cm	12	970.00
ALT ÇIKIŞ					
3155.FA050K.033.1	27371	Ø 50	30 cm	12	563.40
3155.FA050K.040.1	37372	Ø 50	40 cm	12	653.40
3155.FA050K.050.1	37373	Ø 50	50 cm	12	760.00
3155.FA050K.060.1	37374	Ø 50	60 cm	12	823.40
3155.FA050K.080.1	37375	Ø 50	80 cm	12	970.00

Duş kanalı / W300-400-500-600-800 mm / Ø 50 yan - alt çıkış
Plastik gövde / Paslanmaz ızgara ve kasa / Sulu koku tutucu



HM-27970

Pera koku tutucu kullanılmaktadır.

LEGAL T.M.Y360°

Ürün Kodu	Kısa Kod	Çıkış	Ölçü		Fiyat
YAN ÇIKIŞ					
3171.TY050K.033.1	30237	Ø 50	30 cm	12	1063.40
3171.TY050K.040.1	30238	Ø 50	40 cm	12	1206.70
3171.TY050K.050.1	30239	Ø 50	50 cm	12	1490.00
3171.TY050K.060.1	30240	Ø 50	60 cm	12	1653.40
3171.TY050K.080.1	30241	Ø 50	80 cm	12	1953.40
ALT ÇIKIŞ					
3171.TA050K.033.1	30242	Ø 50	30 cm	12	1063.40
3171.TA050K.040.1	30243	Ø 50	40 cm	12	1206.70
3171.TA050K.050.1	30244	Ø 50	50 cm	12	1490.00
3171.TA050K.060.1	30245	Ø 50	60 cm	12	1653.40
3171.TA050K.080.1	30246	Ø 50	80 cm	12	1953.40

Duş kanalı / W300-400-500-600-800 mm / Ø 50 yan - alt çıkış
Plastik gövde / Paslanmaz ızgara ve kasa / Sulu koku tutucu



3172.TY050K



HM-27970

Pera koku tutucu kullanılmaktadır.

LINE FİLELİ Y360°

Ürün Kodu	Kısa Kod	Çıkış	Ölçü		Fiyat
YAN ÇIKIŞ					
3147.FY050K.033.1	30137	Ø 50	30 cm	12	670.00
3147.FY050K.040.1	30138	Ø 50	40 cm	12	756.70
3147.FY050K.050.1	30139	Ø 50	50 cm	12	866.70
3147.FY050K.060.1	30140	Ø 50	60 cm	12	936.70
3147.FY050K.080.1	30141	Ø 50	80 cm	12	1090.00
ALT ÇIKIŞ					
3147.FA050K.033.1	30142	Ø 50	30 cm	12	670.00
3147.FA050K.040.1	30143	Ø 50	40 cm	12	756.70
3147.FA050K.050.1	30144	Ø 50	50 cm	12	866.70
3147.FA050K.060.1	30145	Ø 50	60 cm	12	936.70
3147.FA050K.080.1	30146	Ø 50	80 cm	12	1090.00

Duş kanalı / W300-400-500-600-800 mm / Ø 50 yan - alt çıkış
Plastik gövde / Paslanmaz ızgara ve kasa / Sulu koku tutucu



HM-27970

Pera koku tutucu kullanılmaktadır.

STANDART SERİSİ

PARÇA NO	PARÇA AÇIKLAMASI	MALZEME	ADET
4016.1	Plastik Alt Gövde	ABS	1
4016.2	Koku Tutucu	ABS	1
4016.3	Paslanmaz Izgara	AISI 304	1
4016.4	Yükseklik Ayarlı Montaj Seti	PP	2

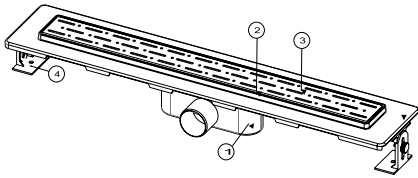

ÜRÜN KODU	W	L	H	Ø D	A	B	C	X	E	B1	A1
4016.DY050K.033.1	423	134	72	49.5	360	88.9	11.35	385	1	56	325
4016.DY050K.040.1	492	134	72	49.5	430	88.9	11.35	456	1	56	395
4016.DY050K.050.1	592	134	72	49.5	530	88.9	11.35	556	1	56	495
4016.DY050K.060.1	693	134	72	49.5	630	88.9	11.35	656	1	56	595
4016.DY050K.080.1	893	134	72	49.5	830	88.9	11.35	856	1	56	795

ÜRÜN KODU	W	L	H	Ø D	A	B	C	X	E	B1	A1
4016.DA050K.033.1	423	134	100	49.5	360	88.9	11.35	385	1	56	325
4016.DA050K.040.1	492	134	100	49.5	430	88.9	11.35	456	1	56	395
4016.DA050K.050.1	592	134	100	49.5	530	88.9	11.35	556	1	56	495
4016.DA050K.060.1	693	134	100	49.5	630	88.9	11.35	656	1	56	595
4016.DA050K.080.1	893	134	100	49.5	830	88.9	11.35	856	1	56	795

Tablo ölçü birimi "mm"dir.

Detaylar

DN 50 Yan ve Alt çıkış – Pvc boru bağlantılarına uyumludur. Akış hızı 32 lt/dk'dır. Izgarası 304 kalite paslanmaz çeliktir.

Avantajlar

304 kalite paslanmaz çelik izgarası sayesinde şık ve kaliteli bir görünüme sahiptir. Duvar dibi uygulamalarda rahatlıkla uygulanabilir. Su tutuculu koku önleyici sayesinde tesisattan gelecek kötü kokuları önler. Yükseltme ayakları sayesinde şapın yüksekliğine göre ayarlama olanağı sağlar. Organik ve inorganik kimyasallara yüksek dayanım. çoğu asidik ve tuzlu su oksidasyonuna dayanıklıdır.

Kullanım Alanları

Genel kullanım banyo duşları, hastane ve otel duş alanları, soyunma odaları duş alanları vb.

Özel Üretim

Izgara modeli olarak isteğinize göre altın, bronz gibi renkler de üretilmektedir.

Uyarı

Yüksek yoğunluklu temizlik malzemelerinin uzun süreli kullanımı tavsiye edilmez.

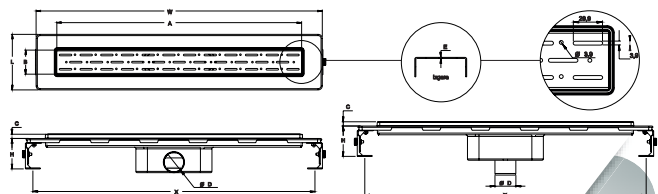

LINE ALÇAK SEVİYELİ

Ürün Kodu	Kısa Kod	Çıkış	Ölçü		Fiyat
ALÇAK SEVİYELİ YAN ÇIKIŞ					
4022.0Y050A.033.1	22310	Ø 50	33 cm	12	616.70
4022.0Y050A.040.1	22382	Ø 50	40 cm	12	670.00
4022.0Y050A.050.1	22391	Ø 50	50 cm	12	790.00
4022.0Y050A.060.1	22400	Ø 50	60 cm	12	870.00
4022.0Y050A.080.1	22409	Ø 50	80 cm	12	1020.00
ALÇAK SEVİYELİ ALT ÇIKIŞ					
4022.0A050A.033.1	22418	Ø 50	33 cm	12	616.70
4022.0A050A.040.1	22426	Ø 50	40 cm	12	670.00
4022.0A050A.050.1	22435	Ø 50	50 cm	12	790.00
4022.0A050A.060.1	22446	Ø 50	60 cm	12	870.00
4022.0A050A.080.1	22459	Ø 50	80 cm	12	1020.00

Duş kanalı / W330-400-500-600 mm / Ø 50 yan - alt çıkış
Plastik gövde / Paslanmaz ızgara / Sulu koku tutucu



LINE

Ürün Kodu	Kısa Kod	Çıkış	Ölçü		Fiyat
YAN ÇIKIŞ					
4022.0Y050K.033.1	16126	Ø 50	30 cm	12	616.70
4022.0Y050K.040.1	16138	Ø 50	40 cm	12	670.00
4022.0Y050K.050.1	16157	Ø 50	50 cm	12	790.00
4022.0Y050K.060.1	16168	Ø 50	60 cm	12	870.00
4022.0Y050K.080.1	16178	Ø 50	80 cm	12	1020.00
ALT ÇIKIŞ					
4022.0A050K.033.1	16159	Ø 50	30 cm	12	616.70
4022.0A050K.040.1	16187	Ø 50	40 cm	12	670.00
4022.0A050K.050.1	16207	Ø 50	50 cm	12	790.00
4022.0A050K.060.1	16231	Ø 50	60 cm	12	870.00
4022.0A050K.080.1	16249	Ø 50	80 cm	12	1020.00

Duş kanalı / W330-400-500-600-800 mm / Ø 50 yan - alt çıkış
Plastik gövde / Paslanmaz ızgara / Sulu koku tutucu



LINE T.M.

Ürün Kodu	Kısa Kod	Çıkış	Ölçü		Fiyat
YAN ÇIKIŞ					
4022.TY050K.033.1	16268	Ø 50	33 cm	12	663.40
4022.TY050K.040.1	16283	Ø 50	40 cm	12	746.70
4022.TY050K.050.1	16298	Ø 50	50 cm	12	866.70
4022.TY050K.060.1	16312	Ø 50	60 cm	12	933.40
4022.TY050K.080.1	16332	Ø 50	80 cm	12	1100.00
ALT ÇIKIŞ					
4022.TA050K.033.1	16363	Ø 50	33 cm	12	663.40
4022.TA050K.040.1	16395	Ø 50	40 cm	12	746.70
4022.TA050K.050.1	16413	Ø 50	50 cm	12	866.70
4022.TA050K.060.1	16436	Ø 50	60 cm	12	933.40
4022.TA050K.080.1	16451	Ø 50	80 cm	12	1100.00

Duş kanalı / W330-400-500-600-800 mm / Ø 50 yan - alt çıkış
Plastik gövde / Paslanmaz ızgara / Sulu koku tutucu





HM-31361

Uzun koku tutucu kullanılmaktadır.



HM-31361

Uzun koku tutucu kullanılmaktadır.

PARÇANO	PARÇA AÇIKLAMASI	MALZEME	ADET
4016.1	Plastik Alt Gövde	ABS	1
4016.2	Koku Tutucu	ABS	1
4016.3	Paslanmaz Izgara	AISI 304	1
4016.4	Yükseklik Ayarlı Montaj Seti	PP	2

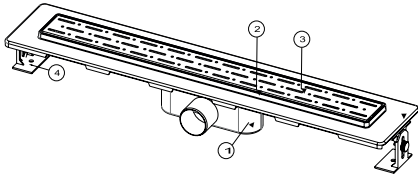

ÜRÜN KODU	W	L	H	Ø D	A	B	C	X	E	B1	A1
4016.0Y050K.033.1	423	134	72	49.5	360	88.9	11.35	385	1	56	325
4016.0Y050K.040.1	492	134	72	49.5	430	88.9	11.35	456	1	56	395
4016.0Y050K.050.1	592	134	72	49.5	530	88.9	11.35	556	1	56	495
4016.0Y050K.060.1	693	134	72	49.5	630	88.9	11.35	656	1	56	595
4016.0Y050K.080.1	893	134	72	49.5	830	88.9	11.35	856	1	56	795

ÜRÜN KODU	W	L	H	Ø D	A	B	C	X	E	B1	A1
4016.0A050K.033.1	423	134	100	49.5	360	88.9	11.35	385	1	56	325
4016.0A050K.040.1	492	134	100	49.5	430	88.9	11.35	456	1	56	395
4016.0A050K.050.1	592	134	100	49.5	530	88.9	11.35	556	1	56	495
4016.0A050K.060.1	693	134	100	49.5	630	88.9	11.35	656	1	56	595
4016.0A050K.080.1	893	134	100	49.5	830	88.9	11.35	856	1	56	795

Tablo ölçü birimi "mm"dir.

DELUXE

Ürün Kodu	Kısa Kod	Çıkış	Ölçü		Fiyat
YAN ÇIKIŞ					
4016.0Y050K.033.1	16462	Ø 50	33 cm	12	910.00
4016.0Y050K.040.1	16486	Ø 50	40 cm	12	1013.40
4016.0Y050K.050.1	16497	Ø 50	50 cm	12	1193.40
4016.0Y050K.060.1	16512	Ø 50	60 cm	12	1350.00
4016.0Y050K.080.1	16527	Ø 50	80 cm	12	1626.70
ALT ÇIKIŞ					
4016.0A050K.033.1	16542	Ø 50	33 cm	12	910.00
4016.0A050K.040.1	16570	Ø 50	40 cm	12	1013.40
4016.0A050K.050.1	16592	Ø 50	50 cm	12	1193.40
4016.0A050K.060.1	16608	Ø 50	60 cm	12	1350.00
4016.0A050K.080.1	16625	Ø 50	80 cm	12	1626.70

Duş kanalı / W330-400-500-600 mm / Ø 50 yan - alt çıkış
Plastik gövde / Paslanmaz ızgara ve çerçeve / Sulu koku tutucu

DELUXE T.M.

Ürün Kodu	Kısa Kod	Çıkış	Ölçü		Fiyat
YAN ÇIKIŞ					
4016.TY050K.033.1	16555	Ø 50	30 cm	12	956.70
4016.TY050K.040.1	16572	Ø 50	40 cm	12	1093.40
4016.TY050K.050.1	16587	Ø 50	50 cm	12	1273.40
4016.TY050K.060.1	16604	Ø 50	60 cm	12	1416.70
4016.TY050K.080.1	16634	Ø 50	80 cm	12	1713.40
ALT ÇIKIŞ					
4016.TA050K.033.1	16643	Ø 50	30 cm	12	956.70
4016.TA050K.040.1	16666	Ø 50	40 cm	12	1093.40
4016.TA050K.050.1	16683	Ø 50	50 cm	12	1273.40
4016.TA050K.060.1	16704	Ø 50	60 cm	12	1416.70
4016.TA050K.080.1	16722	Ø 50	80 cm	12	1713.40

Duş kanalı / W330-400-500-600 mm / Ø 50 yan - alt çıkış
Plastik gövde / Paslanmaz ızgara ve çerçeve / Sulu koku tutucu

Detaylar

DN 50 Yan ve Alt çıkış – Pvc boru bağlantılarına uyumludur. Akış hızı 32 lt/dk'dır. Izgarası 304 kalite paslanmaz çeliktir.

Avantajlar

304 kalite paslanmaz çelik ızgarası sayesinde şık ve kaliteli bir görünüme sahiptir. Duvar dibi uygulamalarda rahatlıkla uygulanabilir. Su tutuculu koku önleyici sayesinde tesisattan gelecek kötü kokuları önler. Yükseltme ayakları sayesinde şapın yüksekliğine göre ayarlama olanağı sağlar. Organik ve inorganik kimyasallara yüksek dayanım. çoğu asidik ve tuzlu su oksidasyonuna dayanıklıdır.

Kullanım Alanları

Genel kullanım banyo duşları. hastane ve otel duş alanları. soyunma odaları duş alanları vb.

Özel Üretim

Izgara modeli olarak isteğinize göre altın, bronz gibi renkler de üretilmektedir.

Uyarı

Yüksek yoğunluklu temizlik malzemelerinin uzun süreli kullanımı tavsiye edilmez.

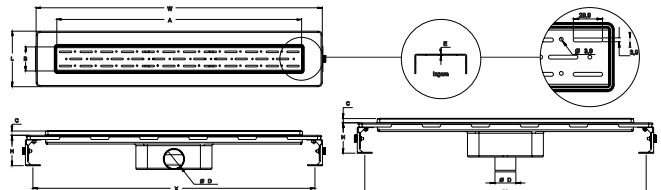

LINE S SIFON

Ürün Kodu	Kısa Kod	Çıkış	Ölçü		Fiyat
YAN ÇIKIŞ					
4123.0Y050K.033.1	34817	Ø 50	33 cm	12	783.40
4123.0Y050K.040.1	34818	Ø 50	40 cm	12	833.40
4123.0Y050K.050.1	34819	Ø 50	50 cm	12	940.00
4123.0Y050K.060.1	34820	Ø 50	60 cm	12	1026.70
4123.0Y050K.080.1	34821	Ø 50	80 cm	12	1236.70

Duş kanalı / W 330-400-500-600-800 mm / Ø 50 yan - alt çıkış
Plastik gövde / Paslanmaz ızgara / Sulu koku tutucu

New



HM-31360

Prime koku tutucu kullanılmaktadır.

LINE

Ürün Kodu	Kısa Kod	Çıkış	Ölçü		Fiyat
YAN ÇIKIŞ					
4023.0Y050K.033.1	16648	Ø 50	33 cm	12	623.40
4023.0Y050K.040.1	16669	Ø 50	40 cm	12	676.70
4023.0Y050K.050.1	16689	Ø 50	50 cm	12	786.70
4023.0Y050K.060.1	16705	Ø 50	60 cm	12	873.40
4023.0Y050K.080.1	18687	Ø 50	80 cm	12	1073.40
ALT ÇIKIŞ					
4023.0A050K.033.1	16723	Ø 50	33 cm	12	623.40
4023.0A050K.040.1	16742	Ø 50	40 cm	12	676.70
4023.0A050K.050.1	16755	Ø 50	50 cm	12	786.70
4023.0A050K.060.1	16769	Ø 50	60 cm	12	873.40
4023.0A050K.080.1	18720	Ø 50	80 cm	12	1073.40

Duş kanalı / W330-400-500-600-800 mm / Ø 50 yan - alt çıkış
Plastik gövde / Paslanmaz ızgara / Sulu koku tutucu



HM-31360

Prime koku tutucu kullanılmaktadır.





HM-31360

Prime koku tutucu kullanılmaktadır.

LINE T.M.

Ürün Kodu	Kısa Kod	Çıkış	Ölçü		Fiyat
YAN ÇIKIŞ					
4023.TY050K.033.1	16739	Ø 50	33 cm	12	726.70
4023.TY050K.040.1	16768	Ø 50	40 cm	12	790.00
4023.TY050K.050.1	16783	Ø 50	50 cm	12	916.70
4023.TY050K.060.1	16800	Ø 50	60 cm	12	1016.70
4023.TY050K.080.1	18739	Ø 50	80 cm	12	1233.40
ALT ÇIKIŞ					
4023.TA050K.033.1	16791	Ø 50	33 cm	12	726.70
4023.TA050K.040.1	16805	Ø 50	40 cm	12	790.00
4023.TA050K.050.1	16818	Ø 50	50 cm	12	916.70
4023.TA050K.060.1	16832	Ø 50	60 cm	12	1016.70
4023.TA050K.080.1	18763	Ø 50	80 cm	12	1233.40

Duş kanalı / W330-400-500-600-800 mm / Ø 50 yan - alt çıkış
Plastik gövde / Paslanmaz ızgara / Sulu koku tutucu

Detaylar

DN 50 Yan ve Alt çıkış – Pvc boru bağlantılarına uyumludur. Akış hızı 32 lt/dk'dır. Izgarası 304 kalite paslanmaz çeliktir.

Avantajlar

304 kalite paslanmaz çelik ızgarası sayesinde şık ve kaliteli bir görünüme sahiptir. Duvar dibi uygulamalarda rahatlıkla uygulanabilir. Su tutuculu koku önleyici sayesinde tesisattan gelecek kötü kokuları önler. Yükseltme ayakları sayesinde şapın yüksekliğine göre ayarlama olanağı sağlar. Organik ve inorganik kimyasallara yüksek dayanım. çoğu asidik ve tuzlu su oksidasyonuna dayanıklıdır.

Kullanım Alanları

Genel kullanım banyo duşları, hastane ve otel duş alanları, soyunma odaları duş alanları vb.

Özel Üretim

Izgara modeli olarak isteğinize göre altın, bronz gibi renkler de üretilmektedir.

Uyarı

Yüksek yoğunluklu temizlik malzemelerinin uzun süreli kullanımı tavsiye edilmez.

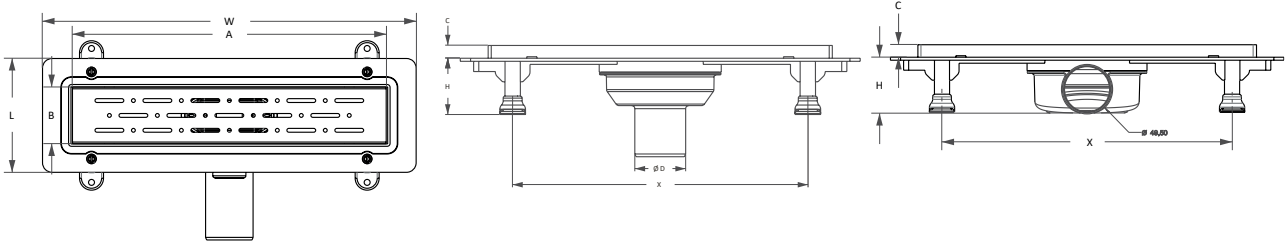

	W	L	H	Ø D	A	B	C	X	E
4023.0Y050K.033.1	389	119	55	50	335	64.5	12.5	287	1
4023.0Y050K.040.1	454	119	55	50	405	64.5	12.5	387	1
4023.0Y050K.050.1	554	119	55	50	505	64.5	12.5	487	1
4023.0Y050K.060.1	654	119	55	50	605	64.5	12.5	587	1
4023.0Y050K.080.1	854	119	55	50	805	64.5	12.5	787	1

	W	L	H	Ø D	A	B	C	X	E
4023.0A050K.033.1	389	119	55	50	335	64.5	12.5	287	1
4023.0A050K.040.1	454	119	55	50	405	64.5	12.5	387	1
4023.0A050K.050.1	554	119	55	50	505	64.5	12.5	487	1
4023.0A050K.060.1	654	119	55	50	605	64.5	12.5	587	1
4023.0A050K.080.1	854	119	55	50	805	64.5	12.5	787	1

Tablo ölçü birimi "mm"dir.



RAIN

KARE

BAHN

DOLU

LEGAL S SIFON

Ürün Kodu	Kısa Kod	Çıkış	Ölçü		Fiyat
YAN ÇIKIŞ					
4124.0Y050K.033.1	34822	Ø 50	33 cm	12	966.70
4124.0Y050K.040.1	34823	Ø 50	40 cm	12	1040.00
4124.0Y050K.050.1	34824	Ø 50	50 cm	12	1190.00
4124.0Y050K.060.1	34825	Ø 50	60 cm	12	1313.40
4124.0Y050K.080.1	34826	Ø 50	80 cm	12	1586.70

Duş kanalı / W330-400-500-600-800 mm / Ø 50 yan - alt çıkış
Plastik gövde / Paslanmaz çerçeve ve ızgara / Sulu koku tutucu



HM-31360

Prime koku tutucu kullanılmaktadır.

LEGAL

Ürün Kodu	Kısa Kod	Çıkış	Ölçü		Fiyat
YAN ÇIKIŞ					
4024.0Y050K.033.1	16842	Ø 50	33 cm	12	790.00
4024.0Y050K.040.1	16857	Ø 50	40 cm	12	873.40
4024.0Y050K.050.1	16880	Ø 50	50 cm	12	1023.40
4024.0Y050K.060.1	16902	Ø 50	60 cm	12	1146.70
4024.0Y050K.080.1	18723	Ø 50	80 cm	12	1413.40

ALT ÇIKIŞ

4024.0A050K.033.1	16841	Ø 50	33 cm	12	790.00
4024.0A050K.040.1	16860	Ø 50	40 cm	12	873.40
4024.0A050K.050.1	16876	Ø 50	50 cm	12	1023.40
4024.0A050K.060.1	16892	Ø 50	60 cm	12	1146.70
4024.0A050K.080.1	18740	Ø 50	80 cm	12	1413.40

Duş kanalı / W330-400-500-600-800 mm / Ø 50 yan - alt çıkış
Plastik gövde / Paslanmaz çerçeve ve ızgara / Sulu koku tutucu



HM-31360

Prime koku tutucu kullanılmaktadır.

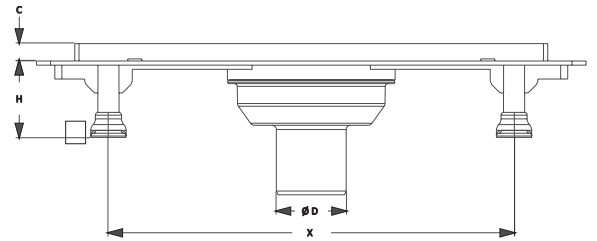
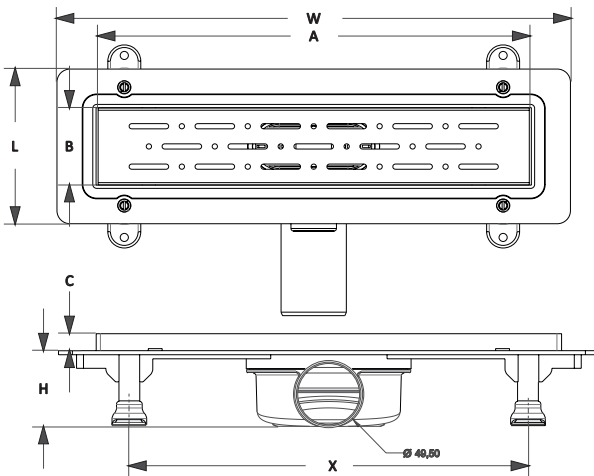

	W	L	H	Ø D	A	B	C	X	E
4024.0A050K.033.1	389	119	55	50	335	64.5	12.5	287	1
4024.0A050K.040.1	454	119	55	50	405	64.5	12.5	387	1
4024.0A050K.050.1	554	119	55	50	505	64.5	12.5	487	1
4024.0A050K.060.1	654	119	55	50	605	64.5	12.5	587	1

	W	L	H	Ø D	A	B	C	X	E
4024.0Y050K.033.1	389	119	55	50	335	64.5	12.5	287	1
4024.0Y050K.040.1	454	119	55	50	405	64.5	12.5	387	1
4024.0Y050K.050.1	554	119	55	50	505	64.5	12.5	487	1
4024.0Y050K.060.1	654	119	55	50	605	64.5	12.5	587	1

Tablo ölçü birimi "mm"dir.

LEGAL T.M.



HM-31360

Prime koku tutucu kullanılmaktadır.

Ürün Kodu	Kısa Kod	Çıkış	Ölçü	Fiyat	
YAN ÇIKIŞ					
4024.TY050K.033.1	16922	Ø 50	33 cm	12	903.40
4024.TY050K.040.1	16940	Ø 50	40 cm	12	993.40
4024.TY050K.050.1	16951	Ø 50	50 cm	12	1160.00
4024.TY050K.060.1	16968	Ø 50	60 cm	12	1300.00
4024.TY050K.080.1	18754	Ø 50	80 cm	12	1583.40
ALT ÇIKIŞ					
4024.TA050K.033.1	16915	Ø 50	33 cm	12	903.40
4024.TA050K.040.1	16941	Ø 50	40 cm	12	993.40
4024.TA050K.050.1	16967	Ø 50	50 cm	12	1160.00
4024.TA050K.060.1	16986	Ø 50	60 cm	12	1300.00
4024.TA050K.080.1	18770	Ø 50	80 cm	12	1583.40

Duş kanalı / W330-400-500-600-800 mm / Ø 50 yan - alt çıkış
Plastik gövde / Paslanmaz çerçeve ve ızgara / Sulu koku tutucu

Detaylar

DN 50 Yan ve Alt çıkış – Pvc boru bağlantılarına uyumludur. Akış hızı 32 lt/dk'dır. Izgarası 304 kalite paslanmaz çeliktir.

Avantajlar

304 kalite paslanmaz çelik ızgarası sayesinde şık ve kaliteli bir görünüme sahiptir. Duvar dibi uygulamalarda rahatlıkla uygulanabilir. Su tutuculu koku önleyici sayesinde tesisattan gelecek kötü kokuları önler. Yükseltme ayakları sayesinde şapın yüksekliğine göre ayarlama olanağı sağlar. Organik ve inorganik kimyasallara yüksek dayanım. çoğu asidik ve tuzlu su oksidasyonuna dayanıklıdır.

Kullanım Alanları

Genel kullanım banyo duşları, hastane ve otel duş alanları, soyunma odaları duş alanları vb.

Özel Üretim

Izgara modeli olarak isteğinize göre altın, bronz gibi renkler de üretilmektedir.

Uyarı

Yüksek yoğunluklu temizlik malzemelerinin uzun süreli kullanımı tavsiye edilmez.

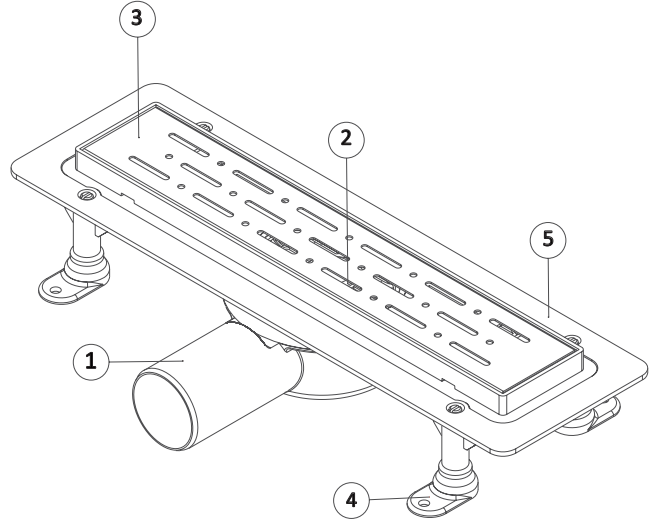

PARÇA NO	PARÇA AÇIKLAMASI	MALZEME	ADET
4023.1	Plastik Alt Gövde	ABS	1
4023.2	Koku Tutucu	ABS	1
4023.3	Paslanmaz Izgara	AISI 304	1
4023.4	Yükseklik Ayarlı Montaj Seti	PP	4
4023.5	Plastik Üst Gövde	PP	1



RAIN

KARE

BAHN

DOLU

DELUXE S SIFON

Ürün Kodu	Kısa Kod	Çıkış	Ölçü		Fiyat
YAN ÇIKIŞ					
4125.0Y050K.033.1	34827	Ø 50	33 cm	12	1076.70
4125.0Y050K.040.1	34828	Ø 50	40 cm	12	1173.40
4125.0Y050K.050.1	34829	Ø 50	50 cm	12	1343.40
4125.0Y050K.060.1	34830	Ø 50	60 cm	12	1503.40
4125.0Y050K.080.1	34831	Ø 50	80 cm	12	1823.40

Duş kanalı / W330-400-500-600-800 mm / Ø 50 yan - alt çıkış
Plastik gövde / Paslanmaz çerçeve ve ızgara / Sulu koku tutucu



HM-31360

Prime koku tutucu kullanılmaktadır.

DELUXE

Ürün Kodu	Kısa Kod	Çıkış	Ölçü		Fiyat
YAN ÇIKIŞ					
4025.0Y050K.033.1	16978	Ø 50	33 cm	12	910.00
4025.0Y050K.040.1	17003	Ø 50	40 cm	12	1013.40
4025.0Y050K.050.1	17031	Ø 50	50 cm	12	1183.40
4025.0Y050K.060.1	17041	Ø 50	60 cm	12	1343.40
4025.0Y050K.080.1	18784	Ø 50	80 cm	12	1656.70
ALT ÇIKIŞ					
4025.0A050K.033.1	17004	Ø 50	33 cm	12	910.00
4025.0A050K.040.1	17018	Ø 50	40 cm	12	1013.40
4025.0A050K.050.1	17030	Ø 50	50 cm	12	1183.40
4025.0A050K.060.1	17071	Ø 50	60 cm	12	1343.40
4025.0A050K.080.1	18795	Ø 50	80 cm	12	1656.70

Duş kanalı / W330-400-500-600-800 mm / Ø 50 yan - alt çıkış
Plastik gövde / Paslanmaz çerçeve ve ızgara / Sulu koku tutucu

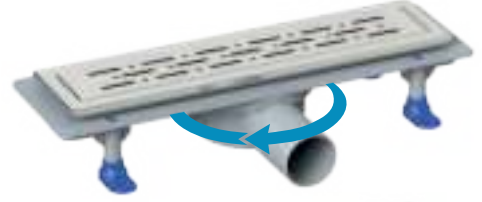

HM-31360

Prime koku tutucu kullanılmaktadır.



DELUXE T.M.



HM-31360

Prime koku tutucu kullanılmaktadır.

Ürün Kodu	Kısa Kod	Çıkış	Ölçü		Fiyat
YAN ÇIKIŞ					
4025.TY050K.033.1	17050	Ø 50	33 cm	12	1016.70
4025.TY050K.040.1	17059	Ø 50	40 cm	12	1130.00
4025.TY050K.050.1	17081	Ø 50	50 cm	12	1316.70
4025.TY050K.060.1	17098	Ø 50	60 cm	12	1493.40
4025.TY050K.080.1	18792	Ø 50	80 cm	12	1820.00
ALT ÇIKIŞ					
4025.TA050K.033.1	17085	Ø 50	33 cm	12	1016.70
4025.TA050K.040.1	17130	Ø 50	40 cm	12	1130.00
4025.TA050K.050.1	17145	Ø 50	50 cm	12	1316.70
4025.TA050K.060.1	17160	Ø 50	60 cm	12	1493.40
4025.TA050K.080.1	18815	Ø 50	80 cm	12	1820.00

Duş kanalı / W330-400-500-600-800 mm / Ø 50 yan - alt çıkış
Plastik gövde / Paslanmaz çerçeve ve ızgara / Sulu koku tutucu

Detaylar

DN 50 Yan ve Alt çıkış – Pvc boru bağlantılarına uyumludur. Akış hızı 32 lt/dk'dır. Izgarası 304 kalite paslanmaz çeliktir.

Avantajlar

304 kalite paslanmaz çelik ızgarası sayesinde şık ve kaliteli bir görünüme sahiptir. Duvar dibi uygulamalarda rahatlıkla uygulanabilir. Su tutuculu koku önleyici sayesinde tesisattan gelecek kötü kokuları önler. Yükseltme ayakları sayesinde şapın yüksekliğine göre ayarlama olanağı sağlar. Organik ve inorganik kimyasallara yüksek dayanım. çoğu asidik ve tuzlu su oksidasyonuna dayanıklıdır.

Kullanım Alanları

Genel kullanım banyo duşları, hastane ve otel duş alanları, soyunma odaları duş alanları vb.

Özel Üretim

Izgara modeli olarak isteğinize göre altın, bronz gibi renkler de üretilmektedir.

Uyarı

Yüksek yoğunluklu temizlik malzemelerinin uzun süreli kullanımı tavsiye edilmez.

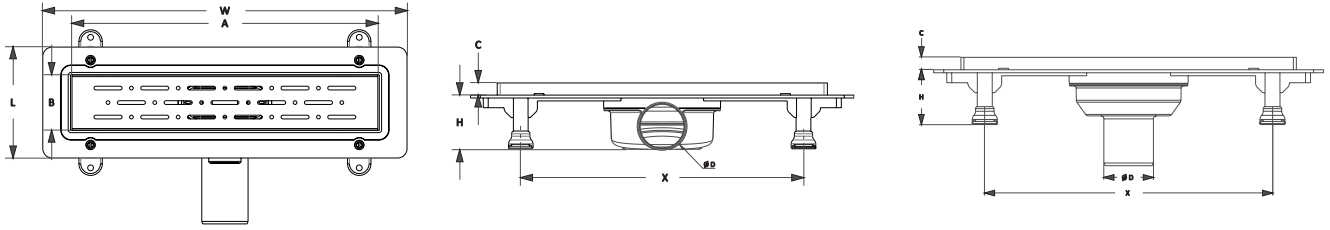

	W	L	H	ØD	A	B	C	X	E
4028.0Y050K.033.1	389	119	55	50	335	64.5	12.5	287	1
4028.0Y050K.040.1	454	119	55	50	405	64.5	12.5	387	1
4028.0Y050K.050.1	554	119	55	50	505	64.5	12.5	487	1
4028.0Y050K.060.1	654	119	55	50	605	64.5	12.5	587	1

	W	L	H	ØD	A	B	C	X	E
4028.0A050K.033.1	389	119	55	50	335	64.5	12.5	287	1
4028.0A050K.040.1	454	119	55	50	405	64.5	12.5	387	1
4028.0A050K.050.1	554	119	55	50	505	64.5	12.5	487	1
4028.0A050K.060.1	654	119	55	50	605	64.5	12.5	587	1

Tablo ölçü birimi "mm"dir.



RAIN

KARE

BAHN

DOLU

SCALA S SIFON

Ürün Kodu	Kısa Kod	Çıkış	Ölçü		Fiyat
YAN ÇIKIŞ					
4126.0Y050K.033.1	34832	Ø 50	33 cm	12	776.70
4126.0Y050K.040.1	34833	Ø 50	40 cm	12	836.70
4126.0Y050K.050.1	34834	Ø 50	50 cm	12	946.70
4126.0Y050K.060.1	34835	Ø 50	60 cm	12	1063.40
4126.0Y050K.080.1	34836	Ø 50	80 cm	12	1233.40

Duş kanalı / W 330-400-500-600-800 mm / Ø 50 yan - alt çıkış
Plastik gövde / Paslanmaz ızgara / Sulu koku tutucu



HM-31360

Prime koku tutucu kullanılmaktadır.

SCALA

Ürün Kodu	Kısa Kod	Çıkış	Ölçü		Fiyat
YAN ÇIKIŞ					
4026.0Y050K.033.1	17107	Ø 50	33 cm	12	610.00
4026.0Y050K.040.1	17108	Ø 50	40 cm	12	673.40
4026.0Y050K.050.1	17109	Ø 50	50 cm	12	786.70
4026.0Y050K.060.1	17110	Ø 50	60 cm	12	903.40
4026.0Y050K.080.1	18806	Ø 50	80 cm	12	1066.70
ALT ÇIKIŞ					
4026.0A050K.033.1	17111	Ø 50	33 cm	12	610.00
4026.0A050K.040.1	17112	Ø 50	40 cm	12	673.40
4026.0A050K.050.1	17113	Ø 50	50 cm	12	786.70
4026.0A050K.060.1	17114	Ø 50	60 cm	12	903.40
4026.0A050K.080.1	18810	Ø 50	80 cm	12	1066.70

Duş kanalı / W 330-400-500-600-800 mm / Ø 50 yan - alt çıkış
Plastik gövde / Paslanmaz ızgara / Sulu koku tutucu

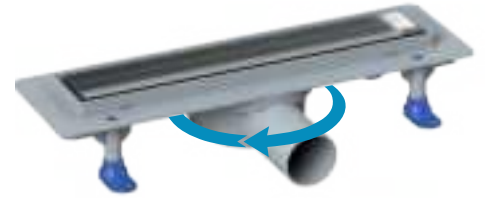

HM-31360

Prime koku tutucu kullanılmaktadır.

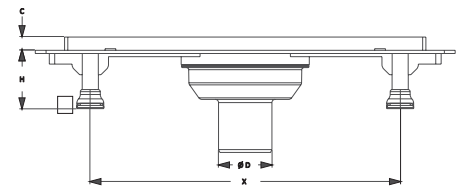
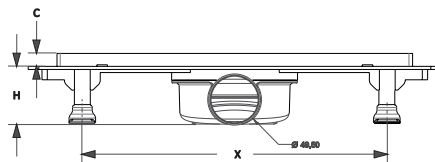
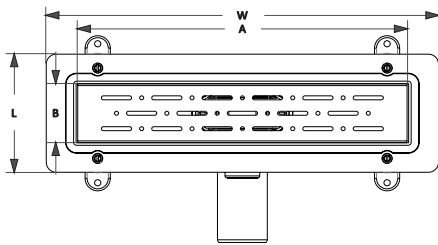

	W	L	H	ØD	A	B	C	X	E
4024.0Y050K.033.1	389	119	55	50	335	64.5	12.5	287	1
4024.0Y050K.040.1	454	119	55	50	405	64.5	12.5	387	1
4024.0Y050K.050.1	554	119	55	50	505	64.5	12.5	487	1
4024.0Y050K.060.1	654	119	55	50	605	64.5	12.5	587	1

	W	L	H	ØD	A	B	C	X	E
4024.0A050K.033.1	389	119	55	50	335	64.5	12.5	287	1
4024.0A050K.040.1	454	119	55	50	405	64.5	12.5	387	1
4024.0A050K.050.1	554	119	55	50	505	64.5	12.5	487	1
4024.0A050K.060.1	654	119	55	50	605	64.5	12.5	587	1

Tablo ölçü birimi "mm"dir.



RAIN



KARE



BAHN



DOLU

SCALA T.M.



HM-31360

Prime koku tutucu kullanılmaktadır.

Ürün Kodu	Kısa Kod	Çıkış	Ölçü		Fiyat
YAN ÇIKIŞ					
4026.TY050K.033.1	17115	Ø 50	33 cm	12	716.70
4026.TY050K.040.1	17116	Ø 50	40 cm	12	790.00
4026.TY050K.050.1	17117	Ø 50	50 cm	12	920.00
4026.TY050K.060.1	17118	Ø 50	60 cm	12	1050.00
4026.TY050K.080.1	18813	Ø 50	80 cm	12	1230.00
ALT ÇIKIŞ					
4026.TA050K.033.1	17119	Ø 50	33 cm	12	716.70
4026.TA050K.040.1	17120	Ø 50	40 cm	12	790.00
4026.TA050K.050.1	17121	Ø 50	50 cm	12	920.00
4026.TA050K.060.1	17122	Ø 50	60 cm	12	1050.00
4026.TA050K.080.1	18816	Ø 50	80 cm	12	1230.00

Duş kanalı / W 330-400-500-600-800 mm / Ø 50 yan - alt çıkış
Plastik gövde / Paslanmaz ızgara / Sulu koku tutucu



SCALA LEGAL S SIFON

Ürün Kodu	Kısa Kod	Çıkış	Ölçü		Fiyat
YAN ÇIKIŞ					
4127.0Y050K.033.1	34837	Ø 50	33 cm	12	920.00
4127.0Y050K.040.1	34838	Ø 50	40 cm	12	1003.40
4127.0Y050K.050.1	34839	Ø 50	50 cm	12	1150.00
4127.0Y050K.060.1	34840	Ø 50	60 cm	12	1296.70
4127.0Y050K.080.1	34841	Ø 50	80 cm	12	1516.70

Duş kanalı / W330-400-500-600-800 mm / Ø 50 yan - alt çıkış
Plastik gövde / Paslanmaz çerçeve ve ızgara / Sulu koku tutucu

New



HM-31360

Prime koku tutucu kullanılmaktadır.

SCALA LEGAL

Ürün Kodu	Kısa Kod	Çıkış	Ölçü		Fiyat
YAN ÇIKIŞ					
4027.0Y050K.033.1	17128	Ø 50	33 cm	12	746.70
4027.0Y050K.040.1	17131	Ø 50	40 cm	12	836.70
4027.0Y050K.050.1	17133	Ø 50	50 cm	12	986.70
4027.0Y050K.060.1	17135	Ø 50	60 cm	12	1130.00
4027.0Y050K.080.1	18818	Ø 50	80 cm	12	1340.00
ALT ÇIKIŞ					
4027.0A050K.033.1	17138	Ø 50	33 cm	12	746.70
4027.0A050K.040.1	17141	Ø 50	40 cm	12	836.70
4027.0A050K.050.1	17143	Ø 50	50 cm	12	986.70
4027.0A050K.060.1	17146	Ø 50	60 cm	12	1130.00
4027.0A050K.080.1	18822	Ø 50	80 cm	12	1340.00

Duş kanalı / W330-400-500-600-800 mm / Ø 50 yan - alt çıkış
Plastik gövde / Paslanmaz çerçeve ve ızgara / Sulu koku tutucu

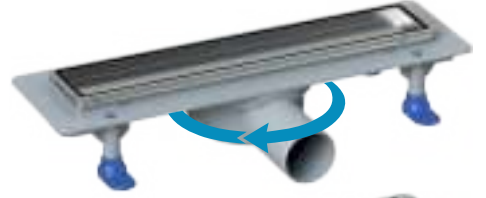

HM-31360

Prime koku tutucu kullanılmaktadır.



SCALA LEGAL T.M.

Ürün Kodu	Kısa Kod	Çıkış	Ölçü		Fiyat
YAN ÇIKIŞ					
4027.TY050K.033.1	17148	Ø 50	33 cm	12	856.70
4027.TY050K.040.1	17151	Ø 50	40 cm	12	956.70
4027.TY050K.050.1	17153	Ø 50	50 cm	12	1123.40
4027.TY050K.060.1	17156	Ø 50	60 cm	12	1283.40
4027.TY050K.080.1	18824	Ø 50	80 cm	12	1513.40
ALT ÇIKIŞ					
4027.TA050K.033.1	17159	Ø 50	33 cm	12	856.70
4027.TA050K.040.1	17161	Ø 50	40 cm	12	956.70
4027.TA050K.050.1	17163	Ø 50	50 cm	12	1123.40
4027.TA050K.060.1	17165	Ø 50	60 cm	12	1283.40
4027.TA050K.080.1	18828	Ø 50	80 cm	12	1513.40

Duş kanalı / W330-400-500-600-800 mm / Ø 50 yan - alt çıkış
Plastik gövde / Paslanmaz çerçeve ve ızgara / Sulu koku tutucu



HM-31360

Prime koku tutucu kullanılmaktadır.

Detaylar

DN 50 Yan ve Alt çıkış – Pvc boru bağlantılarına uyumludur. Akış hızı 32 lt/dk'dır. Izgarası 304 kalite paslanmaz çeliktir.

Avantajlar

304 kalite paslanmaz çelik ızgarası sayesinde şık ve kaliteli bir görünüme sahiptir. Duvar dibi uygulamalarda rahatlıkla uygulanabilir. Su tutuculu koku önleyici sayesinde tesisattan gelecek kötü kokuları önler. Yükseltme ayakları sayesinde şapın yüksekliğine göre ayarlama olanağı sağlar. Organik ve inorganik kimyasallara yüksek dayanım. çoğu asidik ve tuzlu su oksidasyonuna dayanıklıdır.

Kullanım Alanları

Genel kullanım banyo duşları, hastane ve otel duş alanları, soyunma odaları duş alanları vb.

Özel Üretim

Izgara modeli olarak isteğinize göre altın, bronz gibi renkler de üretilmektedir.

Uyarı

Yüksek yoğunluklu temizlik malzemelerinin uzun süreli kullanımı tavsiye edilmez.

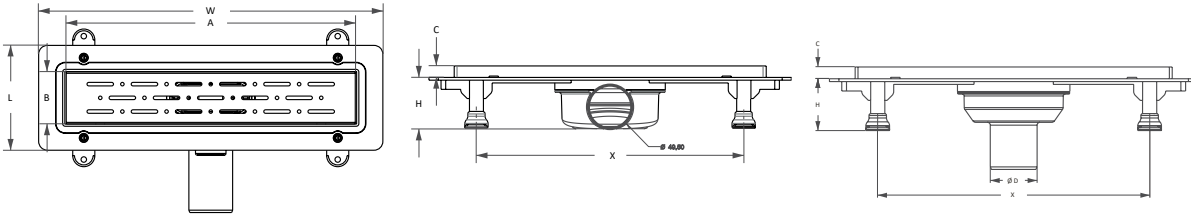

	W	L	H	ØD	A	B	C	X	E
4023.0Y050K.033.1	389	119	55	50	335	64.5	12.5	287	1
4023.0Y050K.040.1	454	119	55	50	405	64.5	12.5	387	1
4023.0Y050K.050.1	554	119	55	50	505	64.5	12.5	487	1
4023.0Y050K.060.1	654	119	55	50	605	64.5	12.5	587	1
4023.0Y050K.080.1	854	119	55	50	805	64.5	12.5	787	1

	W	L	H	ØD	A	B	C	X	E
4023.0A050K.033.1	389	119	55	50	335	64.5	12.5	287	1
4023.0A050K.040.1	454	119	55	50	405	64.5	12.5	387	1
4023.0A050K.050.1	554	119	55	50	505	64.5	12.5	487	1
4023.0A050K.060.1	654	119	55	50	605	64.5	12.5	587	1
4023.0A050K.080.1	854	119	55	50	805	64.5	12.5	787	1

Tablo ölçü birimi "mm"dir.

SCALA DELUXE S SIFON

Ürün Kodu	Kısa Kod	Çıkış	Ölçü		Fiyat
YAN ÇIKIŞ					
4128.0Y050K.033.1	34842	Ø 50	33 cm	12	1086.70
4128.0Y050K.040.1	34843	Ø 50	40 cm	12	1193.40
4128.0Y050K.050.1	34844	Ø 50	50 cm	12	1370.00
4128.0Y050K.060.1	34845	Ø 50	60 cm	12	1563.40
4128.0Y050K.080.1	34846	Ø 50	80 cm	12	1846.70

Duş kanalı / W330-400-500-600-800 mm / Ø 50 yan - alt çıkış
Plastik gövde / Paslanmaz çerçeve ve ızgara / Sulu koku tutucu



HM-31360

Prime koku tutucu kullanılmaktadır.

SCALA DELUXE

Ürün Kodu	Kısa Kod	Çıkış	Ölçü		Fiyat
YAN ÇIKIŞ					
4028.0Y050K.033.1	17173	Ø 50	33 cm	12	913.40
4028.0Y050K.040.1	17176	Ø 50	40 cm	12	1026.70
4028.0Y050K.050.1	17177	Ø 50	50 cm	12	1203.40
4028.0Y050K.060.1	17178	Ø 50	60 cm	12	1396.70
4028.0Y050K.080.1	18830	Ø 50	80 cm	12	1673.40
ALT ÇIKIŞ					
4028.0A050K.033.1	17167	Ø 50	33 cm	12	913.40
4028.0A050K.040.1	17174	Ø 50	40 cm	12	1026.70
4028.0A050K.050.1	17175	Ø 50	50 cm	12	1203.40
4028.0A050K.060.1	17179	Ø 50	60 cm	12	1396.70
4028.0A050K.080.1	18831	Ø 50	80 cm	12	1673.40

Duş kanalı / W330-400-500-600-800 mm / Ø 50 yan - alt çıkış
Plastik gövde / Paslanmaz çerçeve ve ızgara / Sulu koku tutucu



HM-31360

Prime koku tutucu kullanılmaktadır.

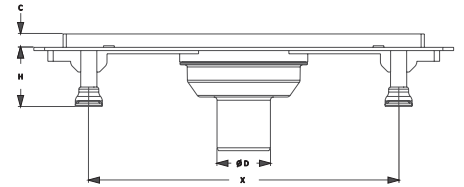
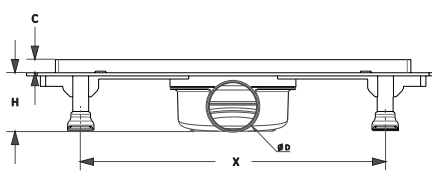
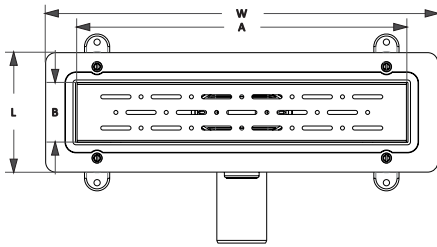

	W	L	H	ØD	A	B	C	X	E
4028.0Y050K.033.1	389	119	55	50	335	64.5	12.5	287	1
4028.0Y050K.040.1	454	119	55	50	405	64.5	12.5	387	1
4028.0Y050K.050.1	554	119	55	50	505	64.5	12.5	487	1
4028.0Y050K.060.1	654	119	55	50	605	64.5	12.5	587	1

	W	L	H	ØD	A	B	C	X	E
4028.0A050K.033.1	389	119	55	50	335	64.5	12.5	287	1
4028.0A050K.040.1	454	119	55	50	405	64.5	12.5	387	1
4028.0A050K.050.1	554	119	55	50	505	64.5	12.5	487	1
4028.0A050K.060.1	654	119	55	50	605	64.5	12.5	587	1

Tablo ölçü birimi "mm"dir.

SCALA DELUXE T.M.



HM-31360

Prime koku tutucu kullanılmaktadır.

Ürün Kodu	Kısa Kod	Çıkış	Ölçü	Fiyat
YAN ÇIKIŞ				
4028.TY050K.033.1	17181	Ø 50	33 cm	1023.40
4028.TY050K.040.1	17182	Ø 50	40 cm	1146.70
4028.TY050K.050.1	17183	Ø 50	50 cm	1340.00
4028.TY050K.060.1	17184	Ø 50	60 cm	1550.00
4028.TY050K.080.1	18832	Ø 50	80 cm	1843.40
ALT ÇIKIŞ				
4028.TA050K.033.1	17180	Ø 50	33 cm	1023.40
4028.TA050K.040.1	17185	Ø 50	40 cm	1146.70
4028.TA050K.050.1	17187	Ø 50	50 cm	1340.00
4028.TA050K.060.1	17188	Ø 50	60 cm	1550.00
4028.TA050K.080.1	18833	Ø 50	80 cm	1843.40

Duş kanalı / W330-400-500-600-800 mm / Ø 50 yan - alt çıkış
Plastik gövde / Paslanmaz çerçeve ve ızgara / Sulu koku tutucu

Detaylar

DN 50 Yan ve Alt çıkış – Pvc boru bağlantılarına uyumludur. Akış hızı 32 lt/dk'dır. Izgarası 304 kalite paslanmaz çeliktir.

Avantajlar

304 kalite paslanmaz çelik ızgarası sayesinde şık ve kaliteli bir görünüme sahiptir. Duvar dibi uygulamalarda rahatlıkla uygulanabilir. Su tutuculu koku önleyici sayesinde tesisattan gelecek kötü kokuları önler. Yükseltme ayakları sayesinde şapın yüksekliğine göre ayarlama olanağı sağlar. Organik ve inorganik kimyasallara yüksek dayanım. çoğu asidik ve tuzlu su oksidasyonuna dayanıklıdır.

Kullanım Alanları

Genel kullanım banyo duşları. hastane ve otel duş alanları. soyunma odaları duş alanları vb.

Özel Üretim

Izgara modeli olarak isteğinize göre altın, bronz gibi renkler de üretilmektedir.

Uyarı

Yüksek yoğunluklu temizlik malzemelerinin uzun süreli kullanımı tavsiye edilmez.



LINE Y360° S SIFON

Ürün Kodu	Kısa Kod	Çıkış	Ölçü	İkili	Fiyat
YAN ÇIKIŞ					
4120.0Y050K.033.1	34847	Ø 50	33 cm	12	870.00
4120.0Y050K.040.1	34848	Ø 50	40 cm	12	916.70
4120.0Y050K.050.1	34849	Ø 50	50 cm	12	1026.70
4120.0Y050K.060.1	34850	Ø 50	60 cm	12	1113.40
4120.0Y050K.080.1	34851	Ø 50	80 cm	12	1323.40

Duş kanalı / W 330-400-500-600-800 mm / Ø 50 yan - alt çıkış
Plastik gövde / Paslanmaz ızgara / Sulu koku tutucu

New



HM-31360

Prime koku tutucu kullanılmaktadır.

LINE Y360°

Ürün Kodu	Kısa Kod	Çıkış	Ölçü	İkili	Fiyat
YAN ÇIKIŞ					
4020.0Y050K.033.1	30257	Ø 50	33 cm	12	706.70
4020.0Y050K.040.1	30261	Ø 50	40 cm	12	756.70
4020.0Y050K.050.1	30265	Ø 50	50 cm	12	866.70
4020.0Y050K.060.1	30269	Ø 50	60 cm	12	953.40
4020.0Y050K.080.1	30273	Ø 50	80 cm	12	1160.00

ALT ÇIKIŞ

4020.0A050K.033.1	30277	Ø 50	33 cm	12	706.70
4020.0A050K.040.1	30281	Ø 50	40 cm	12	756.70
4020.0A050K.050.1	30285	Ø 50	50 cm	12	866.70
4020.0A050K.060.1	30289	Ø 50	60 cm	12	953.40
4020.0A050K.080.1	30293	Ø 50	80 cm	12	1160.00

Duş kanalı / W 330-400-500-600-800 mm / Ø 50 yan - alt çıkış
Plastik gövde / Paslanmaz ızgara / Sulu koku tutucu



HM-31360

Prime koku tutucu kullanılmaktadır.

LINE T.M. Y360°

Ürün Kodu	Kısa Kod	Çıkış	Ölçü	İkili	Fiyat
YAN ÇIKIŞ					
4020.TY050K.033.1	30297	Ø 50	33 cm	12	810.00
4020.TY050K.040.1	30301	Ø 50	40 cm	12	870.00
4020.TY050K.050.1	30305	Ø 50	50 cm	12	993.40
4020.TY050K.060.1	30309	Ø 50	60 cm	12	1096.70
4020.TY050K.080.1	30313	Ø 50	80 cm	12	1320.00

ALT ÇIKIŞ

4020.TA050K.033.1	30317	Ø 50	33 cm	12	810.00
4020.TA050K.040.1	30321	Ø 50	40 cm	12	870.00
4020.TA050K.050.1	30325	Ø 50	50 cm	12	993.40
4020.TA050K.060.1	30329	Ø 50	60 cm	12	1096.70
4020.TA050K.080.1	30333	Ø 50	80 cm	12	1320.00

Duş kanalı / W 330-400-500-600-800 mm / Ø 50 yan - alt çıkış
Plastik gövde / Paslanmaz ızgara / Sulu koku tutucu



HM-31360

Prime koku tutucu kullanılmaktadır.

New



HM-31360

Prime koku tutucu kullanılmaktadır.

LEGAL Y360° S SIFON

Ürün Kodu	Kısa Kod	Çıkış	Ölçü		Fiyat
YAN ÇIKIŞ					
4121.0Y050K.033.1	34852	Ø 50	33 cm	12	1056.70
4121.0Y050K.040.1	34853	Ø 50	40 cm	12	1133.40
4121.0Y050K.050.1	34854	Ø 50	50 cm	12	1280.00
4121.0Y050K.060.1	34855	Ø 50	60 cm	12	1406.70
4121.0Y050K.080.1	34856	Ø 50	80 cm	12	1680.00

Duş kanalı / W330-400-500-600-800 mm / Ø 50 yan - alt çıkış
Plastik gövde / Paslanmaz çerçeve ve ızgara / Sulu koku tutucu

LEGAL Y360°

Ürün Kodu	Kısa Kod	Çıkış	Ölçü		Fiyat
YAN ÇIKIŞ					
4021.0Y050K.033.1	30337	Ø 50	33 cm	12	883.40
4021.0Y050K.040.1	30341	Ø 50	40 cm	12	960.00
4021.0Y050K.050.1	30345	Ø 50	50 cm	12	1106.70
4021.0Y050K.060.1	30349	Ø 50	60 cm	12	1233.40
4021.0Y050K.080.1	30353	Ø 50	80 cm	12	1506.70
ALT ÇIKIŞ					
4021.0A050K.033.1	30357	Ø 50	33 cm	12	883.40
4021.0A050K.040.1	30361	Ø 50	40 cm	12	960.00
4021.0A050K.050.1	30365	Ø 50	50 cm	12	1106.70
4021.0A050K.060.1	30369	Ø 50	60 cm	12	1233.40
4021.0A050K.080.1	30373	Ø 50	80 cm	12	1506.70

Duş kanalı / W330-400-500-600-800 mm / Ø 50 yan - alt çıkış
Plastik gövde / Paslanmaz çerçeve ve ızgara / Sulu koku tutucu



HM-31360

Prime koku tutucu kullanılmaktadır.

LEGAL T.M. Y360°

Ürün Kodu	Kısa Kod	Çıkış	Ölçü		Fiyat
YAN ÇIKIŞ					
4021.TY050K.033.1	30377	Ø 50	33 cm	12	993.40
4021.TY050K.040.1	30381	Ø 50	40 cm	12	1080.00
4021.TY050K.050.1	30385	Ø 50	50 cm	12	1246.70
4021.TY050K.060.1	30389	Ø 50	60 cm	12	1386.70
4021.TY050K.080.1	30393	Ø 50	80 cm	12	1676.70
ALT ÇIKIŞ					
4021.TA050K.033.1	30397	Ø 50	33 cm	12	993.40
4021.TA050K.040.1	30401	Ø 50	40 cm	12	1080.00
4021.TA050K.050.1	30405	Ø 50	50 cm	12	1246.70
4021.TA050K.060.1	30409	Ø 50	60 cm	12	1386.70
4021.TA050K.080.1	30413	Ø 50	80 cm	12	1676.70

Duş kanalı / W330-400-500-600-800 mm / Ø 50 yan - alt çıkış
Plastik gövde / Paslanmaz çerçeve ve ızgara / Sulu koku tutucu



HM-31360

Prime koku tutucu kullanılmaktadır.

DELUXE Y360° S SIFON

Ürün Kodu	Kısa Kod	Çıkış	Ölçü		Fiyat
YAN ÇIKIŞ					
4129.0Y050K.033.1	34857	Ø 50	33 cm	12	1163.40
4129.0Y050K.040.1	34858	Ø 50	40 cm	12	1263.40
4129.0Y050K.050.1	34859	Ø 50	50 cm	12	1433.40
4129.0Y050K.060.1	34860	Ø 50	60 cm	12	1593.40
4129.0Y050K.080.1	34861	Ø 50	80 cm	12	1913.40

Duş kanalı / W330-400-500-600-800 mm / Ø 50 yan - alt çıkış
Plastik gövde / Paslanmaz çerçeve ve ızgara / Sulu koku tutucu

New



HM-31360

Prime koku tutucu kullanılmaktadır.

DELUXE Y360°

Ürün Kodu	Kısa Kod	Çıkış	Ölçü		Fiyat
YAN ÇIKIŞ					
4029.0Y050K.033.1	30417	Ø 50	33 cm	12	996.70
4029.0Y050K.040.1	30421	Ø 50	40 cm	12	1096.70
4029.0Y050K.050.1	30425	Ø 50	50 cm	12	1263.40
4029.0Y050K.060.1	30429	Ø 50	60 cm	12	1426.70
4029.0Y050K.080.1	30433	Ø 50	80 cm	12	1746.70
ALT ÇIKIŞ					
4029.0A050K.033.1	30437	Ø 50	33 cm	12	996.70
4029.0A050K.040.1	30441	Ø 50	40 cm	12	1096.70
4029.0A050K.050.1	30445	Ø 50	50 cm	12	1263.40
4029.0A050K.060.1	30449	Ø 50	60 cm	12	1426.70
4029.0A050K.080.1	30453	Ø 50	80 cm	12	1746.70

Duş kanalı / W330-400-500-600-800 mm / Ø 50 yan - alt çıkış
Plastik gövde / Paslanmaz çerçeve ve ızgara / Sulu koku tutucu



HM-31360

Prime koku tutucu kullanılmaktadır.

DELUXE T.M. Y360°

Ürün Kodu	Kısa Kod	Çıkış	Ölçü		Fiyat
YAN ÇIKIŞ					
4029.TY050K.033.1	30457	Ø 50	33 cm	12	1103.40
4029.TY050K.040.1	30461	Ø 50	40 cm	12	1213.40
4029.TY050K.050.1	30465	Ø 50	50 cm	12	1396.70
4029.TY050K.060.1	30469	Ø 50	60 cm	12	1573.40
4029.TY050K.080.1	30473	Ø 50	80 cm	12	1910.00
ALT ÇIKIŞ					
4029.TA050K.033.1	30477	Ø 50	33 cm	12	1103.40
4029.TA050K.040.1	30481	Ø 50	40 cm	12	1213.40
4029.TA050K.050.1	30485	Ø 50	50 cm	12	1396.70
4029.TA050K.060.1	30489	Ø 50	60 cm	12	1573.40
4029.TA050K.080.1	30493	Ø 50	80 cm	12	1910.00

Duş kanalı / W330-400-500-600-800 mm / Ø 50 yan - alt çıkış
Plastik gövde / Paslanmaz çerçeve ve ızgara / Sulu koku tutucu



HM-31360

Prime koku tutucu kullanılmaktadır.

New



HM-31360

Prime koku tutucu kullanılmaktadır.

SCALA Y360° S SIFON

Ürün Kodu	Kısa Kod	Çıkış	Ölçü		Fiyat
YAN ÇIKIŞ					
4130.0Y050K.033.1	34862	Ø 50	33 cm	12	866.70
4130.0Y050K.040.1	34863	Ø 50	40 cm	12	923.40
4130.0Y050K.050.1	34864	Ø 50	50 cm	12	1036.70
4130.0Y050K.060.1	34865	Ø 50	60 cm	12	1153.40
4130.0Y050K.080.1	34866	Ø 50	80 cm	12	1323.40

Duş kanalı / W 330-400-500-600-800 mm / Ø 50 yan - alt çıkış
Plastik gövde / Paslanmaz ızgara / Sulu koku tutucu

SCALA Y360°

Ürün Kodu	Kısa Kod	Çıkış	Ölçü		Fiyat
YAN ÇIKIŞ					
4030.0Y050K.033.1	30497	Ø 50	33 cm	12	700.00
4030.0Y050K.040.1	30501	Ø 50	40 cm	12	756.70
4030.0Y050K.050.1	30505	Ø 50	50 cm	12	866.70
4030.0Y050K.060.1	30509	Ø 50	60 cm	12	983.40
4030.0Y050K.080.1	30513	Ø 50	80 cm	12	1156.70
ALT ÇIKIŞ					
4030.0A050K.033.1	30517	Ø 50	33 cm	12	700.00
4030.0A050K.040.1	30521	Ø 50	40 cm	12	756.70
4030.0A050K.050.1	30525	Ø 50	50 cm	12	866.70
4030.0A050K.060.1	30529	Ø 50	60 cm	12	983.40
4030.0A050K.080.1	30533	Ø 50	80 cm	12	1156.70

Duş kanalı / W 330-400-500-600-800 mm / Ø 50 yan - alt çıkış
Plastik gövde / Paslanmaz ızgara / Sulu koku tutucu



HM-31360

Prime koku tutucu kullanılmaktadır.

SCALA T.M. Y360°

Ürün Kodu	Kısa Kod	Çıkış	Ölçü		Fiyat
YAN ÇIKIŞ					
4030.TY050K.033.1	30537	Ø 50	33 cm	12	806.70
4030.TY050K.040.1	30541	Ø 50	40 cm	12	873.40
4030.TY050K.050.1	30545	Ø 50	50 cm	12	1000.00
4030.TY050K.060.1	30549	Ø 50	60 cm	12	1133.40
4030.TY050K.080.1	30553	Ø 50	80 cm	12	1320.00
ALT ÇIKIŞ					
4030.TA050K.033.1	30557	Ø 50	33 cm	12	806.70
4030.TA050K.040.1	30561	Ø 50	40 cm	12	873.40
4030.TA050K.050.1	30565	Ø 50	50 cm	12	1000.00
4030.TA050K.060.1	30569	Ø 50	60 cm	12	1133.40
4030.TA050K.080.1	30573	Ø 50	80 cm	12	1320.00

Duş kanalı / W 330-400-500-600-800 mm / Ø 50 yan - alt çıkış
Plastik gövde / Paslanmaz ızgara / Sulu koku tutucu



HM-31360

Prime koku tutucu kullanılmaktadır.

SCALA LEGAL Y360° S SİFON

Ürün Kodu	Kısa Kod	Çıkış	Ölçü		Fiyat
YAN ÇIKIŞ					
4131.0Y050K.033.1	34867	Ø 50	33 cm	12	1013.40
4131.0Y050K.040.1	34868	Ø 50	40 cm	12	1096.70
4131.0Y050K.050.1	34869	Ø 50	50 cm	12	1243.40
4131.0Y050K.060.1	34870	Ø 50	60 cm	12	1386.70
4131.0Y050K.080.1	34871	Ø 50	80 cm	12	1610.00

Duş kanalı / W330-400-500-600-800 mm / Ø 50 yan - alt çıkış
Plastik gövde / Paslanmaz çerçeve ve ızgara / Sulu koku tutucu



HM-31360

Prime koku tutucu kullanılmaktadır.

SCALA LEGAL Y360°

Ürün Kodu	Kısa Kod	Çıkış	Ölçü		Fiyat
YAN ÇIKIŞ					
4031.0Y050K.033.1	30577	Ø 50	33 cm	12	840.00
4031.0Y050K.040.1	30581	Ø 50	40 cm	12	923.40
4031.0Y050K.050.1	30585	Ø 50	50 cm	12	1070.00
4031.0Y050K.060.1	30589	Ø 50	60 cm	12	1213.40
4031.0Y050K.080.1	30593	Ø 50	80 cm	12	1433.40

ALT ÇIKIŞ

4031.0A050K.033.1	30597	Ø 50	33 cm	12	840.00
4031.0A050K.040.1	30601	Ø 50	40 cm	12	923.40
4031.0A050K.050.1	30605	Ø 50	50 cm	12	1070.00
4031.0A050K.060.1	30609	Ø 50	60 cm	12	1213.40
4031.0A050K.080.1	30613	Ø 50	80 cm	12	1433.40

Duş kanalı / W330-400-500-600-800 mm / Ø 50 yan - alt çıkış
Plastik gövde / Paslanmaz çerçeve ve ızgara / Sulu koku tutucu



HM-31360

Prime koku tutucu kullanılmaktadır.

SCALA LEGAL T.M. Y360°

Ürün Kodu	Kısa Kod	Çıkış	Ölçü		Fiyat
YAN ÇIKIŞ					
4031.TY050K.033.1	30617	Ø 50	33 cm	12	950.00
4031.TY050K.040.1	30621	Ø 50	40 cm	12	1043.40
4031.TY050K.050.1	30625	Ø 50	50 cm	12	1206.70
4031.TY050K.060.1	30629	Ø 50	60 cm	12	1366.70
4031.TY050K.080.1	30633	Ø 50	80 cm	12	1606.70

ALT ÇIKIŞ

4031.TA050K.033.1	30637	Ø 50	33 cm	12	950.00
4031.TA050K.040.1	30641	Ø 50	40 cm	12	1043.40
4031.TA050K.050.1	30645	Ø 50	50 cm	12	1206.70
4031.TA050K.060.1	30649	Ø 50	60 cm	12	1366.70
4031.TA050K.080.1	30653	Ø 50	80 cm	12	1606.70

Duş kanalı / W330-400-500-600-800 mm / Ø 50 yan - alt çıkış
Plastik gövde / Paslanmaz çerçeve ve ızgara / Sulu koku tutucu



HM-31360

Prime koku tutucu kullanılmaktadır.



HM-31360

Prime koku tutucu kullanılmaktadır.

SCALA DELUXE Y360° S SIFON

Ürün Kodu	Kısa Kod	Çıkış	Ölçü		Fiyat
YAN ÇIKIŞ					
4134.0Y050K.033.1	34872	Ø 50	33 cm	12	1176.70
4134.0Y050K.040.1	34873	Ø 50	40 cm	12	1286.70
4134.0Y050K.050.1	34874	Ø 50	50 cm	12	1460.00
4134.0Y050K.060.1	34875	Ø 50	60 cm	12	1653.40
4134.0Y050K.080.1	34876	Ø 50	80 cm	12	1940.00

*Duş kanalı / W330-400-500-600-800 mm / Ø 50 yan - alt çıkış
Plastik gövde / Paslanmaz çerçeve ve ızgara / Sulu koku tutucu*

SCALA DELUXE Y360°

Ürün Kodu	Kısa Kod	Çıkış	Ölçü		Fiyat
YAN ÇIKIŞ					
4034.0Y050K.033.1	30657	Ø 50	33 cm	12	1003.40
4034.0Y050K.040.1	30661	Ø 50	40 cm	12	1113.40
4034.0Y050K.050.1	30665	Ø 50	50 cm	12	1286.70
4034.0Y050K.060.1	30669	Ø 50	60 cm	12	1480.00
4034.0Y050K.080.1	30673	Ø 50	80 cm	12	1766.70
ALT ÇIKIŞ					
4034.0A050K.033.1	30677	Ø 50	33 cm	12	1003.40
4034.0A050K.040.1	30681	Ø 50	40 cm	12	1113.40
4034.0A050K.050.1	30685	Ø 50	50 cm	12	1286.70
4034.0A050K.060.1	30689	Ø 50	60 cm	12	1480.00
4034.0A050K.080.1	30693	Ø 50	80 cm	12	1766.70

*Duş kanalı / W330-400-500-600-800 mm / Ø 50 yan - alt çıkış
Plastik gövde / Paslanmaz çerçeve ve ızgara / Sulu koku tutucu*



HM-31360

Prime koku tutucu kullanılmaktadır.

SCALA DELUXE T.M. Y360°

Ürün Kodu	Kısa Kod	Çıkış	Ölçü		Fiyat
YAN ÇIKIŞ					
4034.TY050K.033.1	30697	Ø 50	33 cm	12	1113.40
4034.TY050K.040.1	30701	Ø 50	40 cm	12	1233.40
4034.TY050K.050.1	30705	Ø 50	50 cm	12	1423.40
4034.TY050K.060.1	30709	Ø 50	60 cm	12	1636.70
4034.TY050K.080.1	30713	Ø 50	80 cm	12	1936.70
ALT ÇIKIŞ					
4034.TA050K.033.1	30717	Ø 50	33 cm	12	1113.40
4034.TA050K.040.1	30721	Ø 50	40 cm	12	1233.40
4034.TA050K.050.1	30725	Ø 50	50 cm	12	1423.40
4034.TA050K.060.1	30729	Ø 50	60 cm	12	1636.70
4034.TA050K.080.1	30733	Ø 50	80 cm	12	1936.70

*Duş kanalı / W330-400-500-600-800 mm / Ø 50 yan - alt çıkış
Plastik gövde / Paslanmaz çerçeve ve ızgara / Sulu koku tutucu*



HM-31360

Prime koku tutucu kullanılmaktadır.

LINE

Ürün Kodu	Kısa Kod	Çıkış	Ölçü		Fiyat
YAN ÇIKIŞ					
4033.0Y050K.033.1	17186	Ø 50	33 cm	12	940.00
4033.0Y050K.040.1	17203	Ø 50	40 cm	12	1043.40
4033.0Y050K.050.1	17216	Ø 50	50 cm	12	1306.70
4033.0Y050K.060.1	17236	Ø 50	60 cm	12	1460.00
4033.0Y050K.080.1	17249	Ø 50	80 cm	12	1720.00
ALT ÇIKIŞ					
4033.0A050K.033.1	17189	Ø 50	33 cm	12	940.00
4033.0A050K.040.1	17214	Ø 50	40 cm	12	1043.40
4033.0A050K.050.1	17233	Ø 50	50 cm	12	1306.70
4033.0A050K.060.1	17261	Ø 50	60 cm	12	1460.00
4033.0A050K.080.1	17282	Ø 50	80 cm	12	1720.00

Duş kanalı / W330-400-500-600 mm / Ø 50 yan - alt çıkış
Paslanmaz gövde / Paslanmaz kasa ve ızgara / Sulu koku tutucu



HM-31361

Uzun koku tutucu kullanılmaktadır.

LINE T.M.

Ürün Kodu	Kısa Kod	Çıkış	Ölçü		Fiyat
YAN ÇIKIŞ					
4033.TY050K.033.1	17358	Ø 50	33 cm	12	986.70
4033.TY050K.040.1	17372	Ø 50	40 cm	12	1116.70
4033.TY050K.050.1	17398	Ø 50	50 cm	12	1383.40
4033.TY050K.060.1	17410	Ø 50	60 cm	12	1523.40
4033.TY050K.080.1	17434	Ø 50	80 cm	12	1796.70
ALT ÇIKIŞ					
4033.TA050K.033.1	17385	Ø 50	33 cm	12	986.70
4033.TA050K.040.1	17411	Ø 50	40 cm	12	1116.70
4033.TA050K.050.1	17426	Ø 50	50 cm	12	1383.40
4033.TA050K.060.1	17444	Ø 50	60 cm	12	1523.40
4033.TA050K.080.1	17467	Ø 50	80 cm	12	1796.70

Duş kanalı / W330-400-500-600 mm / Ø 50 yan - alt çıkış
Paslanmaz gövde / Paslanmaz kasa ve ızgara / Sulu koku tutucu



HM-31361

Uzun koku tutucu kullanılmaktadır.

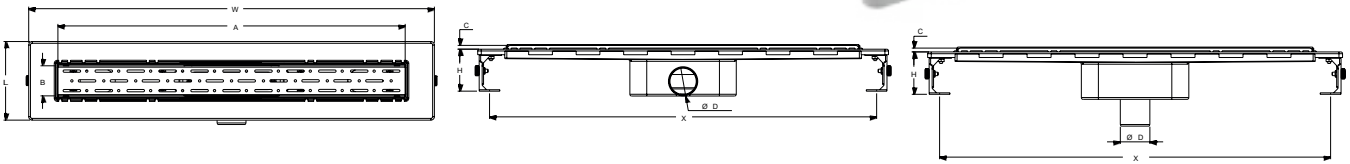

ÜRÜN KODU	W	L	H	Ø D	A	B	C	X	E
4033.TY050K.033.1	423	134	72	49.5	330	54	8	385	1
4033.TY050K.040.1	492	134	72	49.5	400	54	8	456	1
4033.TY050K.050.1	592	134	72	49.5	500	54	8	556	1
4033.TY050K.060.1	693	134	72	49.5	600	54	8	656	1
4033.TY050K.080.1	893	134	72	49.5	800	54	8	856	1

ÜRÜN KODU	W	L	H	Ø D	A	B	C	X	E
4033.TA050K.033.1	423	134	100	49.5	330	54	8	385	1
4033.TA050K.040.1	492	134	100	49.5	400	54	8	456	1
4033.TA050K.050.1	592	134	100	49.5	500	54	8	556	1
4033.TA050K.060.1	693	134	100	49.5	600	54	8	656	1
4033.TA050K.080.1	893	134	100	49.5	800	54	8	856	1

Tablo ölçü birimi "mm"dir.

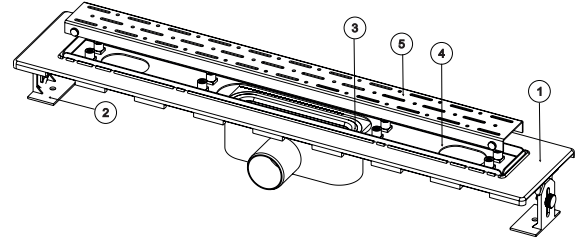

PARÇA NO	PARÇA AÇIKLAMASI	MALZEME	ADET
4033.1	Plastik Gövde Etekli	ABS	1
4033.2	Yükseklik Ayarlı Montaj Seti	PP	2
4033.3	Koku Tutucu	ABS	1
4033.4	Yük. Ayarlı Çerçeve	AISI 304	1
4033.5	Paslanmaz Iızgara	AISI 304	1

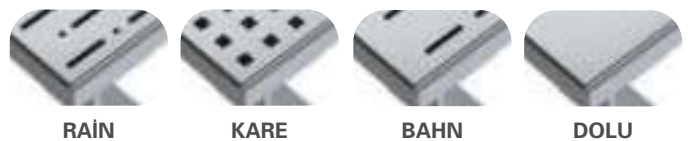



HM-31363

Legal koku tutucu kullanılmaktadır.

LEGAL

Ürün Kodu	Kısa Kod	Çıkış	Ölçü		Fiyat
YAN ÇIKIŞ					
4043.0Y050K.033.1	17524	Ø 50	33 cm	12	1543.40
4043.0Y050K.040.1	17538	Ø 50	40 cm	12	1716.70
4043.0Y050K.050.1	17557	Ø 50	50 cm	12	2090.00
4043.0Y050K.060.1	17575	Ø 50	60 cm	12	2356.70
4043.0Y050K.080.1	18834	Ø 50	80 cm	12	2826.70
ALT ÇIKIŞ					
4043.0A050K.033.1	17601	Ø 50	33 cm	12	1543.40
4043.0A050K.040.1	17619	Ø 50	40 cm	12	1716.70
4043.0A050K.050.1	17640	Ø 50	50 cm	12	2090.00
4043.0A050K.060.1	17661	Ø 50	60 cm	12	2356.70
4043.0A050K.080.1	18994	Ø 50	80 cm	12	2826.70

Duş kanalı / W330-400-500-600-800 mm / Ø 50 yan - alt çıkış
Paslanmaz gövde / Paslanmaz ızgara / Sulu koku tutucu

LEGAL T.M.

Ürün Kodu	Kısa Kod	Çıkış	Ölçü		Fiyat
YAN ÇIKIŞ					
4043.TY050K.033.1	17717	Ø 50	33 cm	12	1593.40
4043.TY050K.040.1	17732	Ø 50	40 cm	12	1796.70
4043.TY050K.050.1	17750	Ø 50	50 cm	12	2170.00
4043.TY050K.060.1	17767	Ø 50	60 cm	12	2423.40
4043.TY050K.080.1	17783	Ø 50	80 cm	12	2910.00
ALT ÇIKIŞ					
4043.TA050K.033.1	17771	Ø 50	33 cm	12	1593.40
4043.TA050K.040.1	17789	Ø 50	40 cm	12	1796.70
4043.TA050K.050.1	17801	Ø 50	50 cm	12	2170.00
4043.TA050K.060.1	17810	Ø 50	60 cm	12	2423.40
4043.TA050K.080.1	17823	Ø 50	80 cm	12	2910.00

Duş kanalı / W330-400-500-600-800 mm / Ø 50 yan - alt çıkış
Paslanmaz gövde / Paslanmaz ızgara / Sulu koku tutucu



HM-31363

Legal koku tutucu kullanılmaktadır.

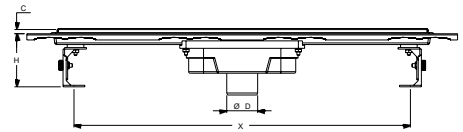
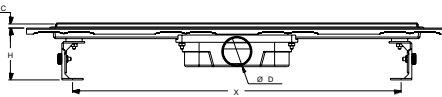
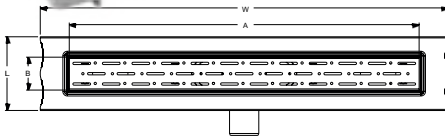

ÜRÜN KODU	W	L	H	ØD	A	B	C	X	E
4043.TY050K.033.1	423	134	85	49.5	330	54	8	385	1
4043.TY050K.040.1	492	134	85	49.5	400	54	8	456	1
4043.TY050K.050.1	592	134	85	49.5	500	54	8	556	1
4043.TY050K.060.1	693	134	85	49.5	600	54	8	656	1
4043.TY050K.080.1	893	134	85	49.5	800	54	8	856	1

PARÇA NO	PARÇA AÇIKLAMASI	MALZEME	ADET
4043.1	Plastik Alt Gövde	ABS	1
4043.2	Paslanmaz Üst Gövde	AISI 304	1
4043.3	Yükseklik Ayarlı Montaj Seti	PP	2
4043.4	Yükseklik Ayarlı Çerçeve	AISI 304	1
4043.5	Paslanmaz Izgara	AISI 304	1
4043.6	Koku Tutucu	ABS	1

ÜRÜN KODU	W	L	H	ØD	A	B	C	X	E
4043.TA050K.033.1	423	134	100	49.5	330	54	8	385	1
4043.TA050K.040.1	492	134	100	49.5	400	54	8	456	1
4043.TA050K.050.1	592	134	100	49.5	500	54	8	556	1
4043.TA050K.060.1	693	134	100	49.5	600	54	8	656	1
4043.TA050K.080.1	893	134	100	49.5	800	54	8	856	1

Tablo ölçü birimi "mm"dir.

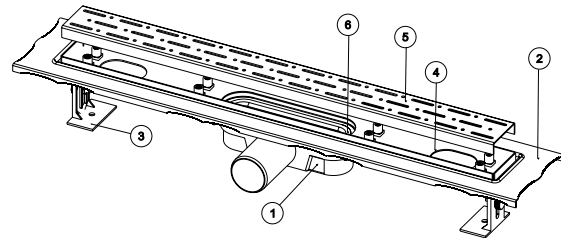



HM-31363

Legal koku tutucu kullanılmaktadır.

LEGAL Y360°

Ürün Kodu	Kısa Kod	Çıkış	Ölçü		Fiyat
YAN ÇIKIŞ					
4043.0Y360K.033.1	18012	Ø 50	33 cm	12	1663.40
4043.0Y360K.040.1	18021	Ø 50	40 cm	12	1833.40
4043.0Y360K.050.1	18030	Ø 50	50 cm	12	2206.70
4043.0Y360K.060.1	18039	Ø 50	60 cm	12	2480.00
4043.0Y360K.080.1	18048	Ø 50	80 cm	12	2950.00
ALT ÇIKIŞ					
4043.0A360K.033.1	31395	Ø 50	33 cm	12	1663.40
4043.0A360K.040.1	31396	Ø 50	40 cm	12	1833.40
4043.0A360K.050.1	31397	Ø 50	50 cm	12	2206.70
4043.0A360K.060.1	31398	Ø 50	60 cm	12	2480.00
4043.0A360K.080.1	31399	Ø 50	80 cm	12	2950.00

Duş kanalı / W330-400-500-600-800 mm / Ø 50 yan - alt çıkış
Paslanmaz gövde / Paslanmaz ızgara / Sulu koku tutucu

PREMIUM

Ürün Kodu	Kısa Kod	Çıkış	Ölçü		Fiyat
YAN ÇIKIŞ					
4045.0Y050K.033.9	18059	Ø 50	33 cm	12	3006.70
4045.0Y050K.045.9	18062	Ø 50	45 cm	12	3593.40
4045.0Y050K.060.9	18065	Ø 50	60 cm	12	4643.40
4045.0Y050K.080.9	18068	Ø 50	80 cm	12	5980.00
ALT ÇIKIŞ					
4045.0A050K.033.9	18070	Ø 50	33 cm	12	3006.70
4045.0A050K.045.9	18072	Ø 50	45 cm	12	3593.40
4045.0A050K.060.9	18074	Ø 50	60 cm	12	4643.40
4045.0A050K.080.9	18076	Ø 50	80 cm	12	5980.00

Duş kanalı / W330-400-500-600-800 mm / Ø 50 yan - alt çıkış
Paslanmaz gövde / Paslanmaz ızgara / Sulu koku tutucu



HM-31363

Legal koku tutucu kullanılmaktadır.

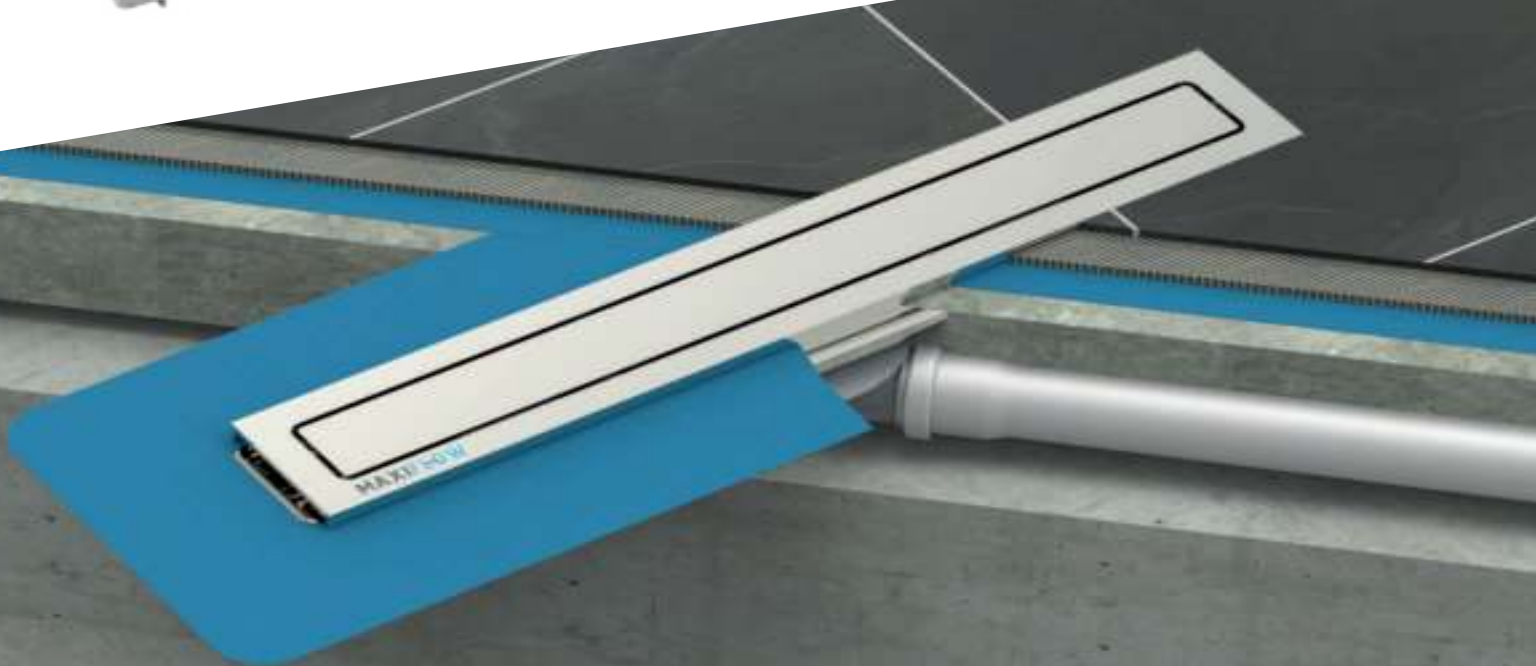

New



LUX LEGAL

Ürün Kodu	Kısa Kod	Çıkış	Ölçü	Fiyat
YAN ÇIKIŞ				
4050.0Y040K.020.1	32616	Ø 40	20 cm	1900.00
4050.0Y040K.033.1	32617	Ø 40	33 cm	2336.70
4050.0Y040K.040.1	32618	Ø 40	40 cm	2626.70
4050.0Y040K.050.1	32619	Ø 40	50 cm	3006.70
4050.0Y040K.060.1	32620	Ø 40	60 cm	3330.00
4050.0Y040K.080.1	32621	Ø 40	80 cm	3920.00

Duş kanalı / W200-330-400-500-600-800 mm / Ø 40 yan
Paslanmaz gövde / Paslanmaz ızgara / Sulu koku tutucu



Legal koku tutucu kullanılmaktadır.

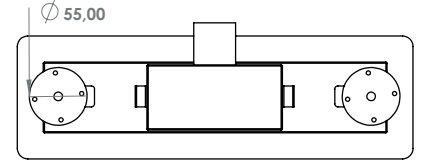
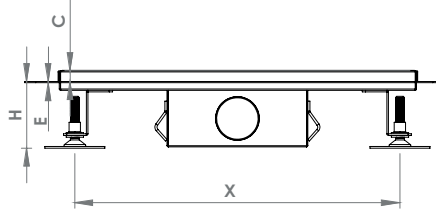
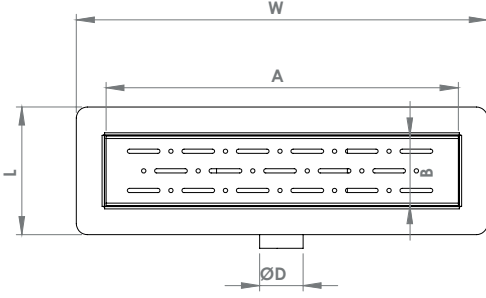

	W	L	H	ØD	A	B	C	X	E
4050.0Y040K.020.1	246	117	60	40	196	64	10	221	1.5
4050.0Y040K.033.1	377	117	60	40	323	64	10	298	1.5
4050.0Y040K.040.1	446	117	60	40	392	64	10	417	1.5
4050.0Y040K.050.1	546	117	60	40	492	64	10	517	1.5
4050.0Y040K.060.1	646	117	60	40	592	64	10	617	1.5
4050.0Y040K.080.1	834	117	60	40	778	64	10	755	1.5





HM-31361

Uzun koku tutucu kullanılmaktadır.



HM-31363

Legal koku tutucu kullanılmaktadır.



HM-31363

Legal koku tutucu kullanılmaktadır.

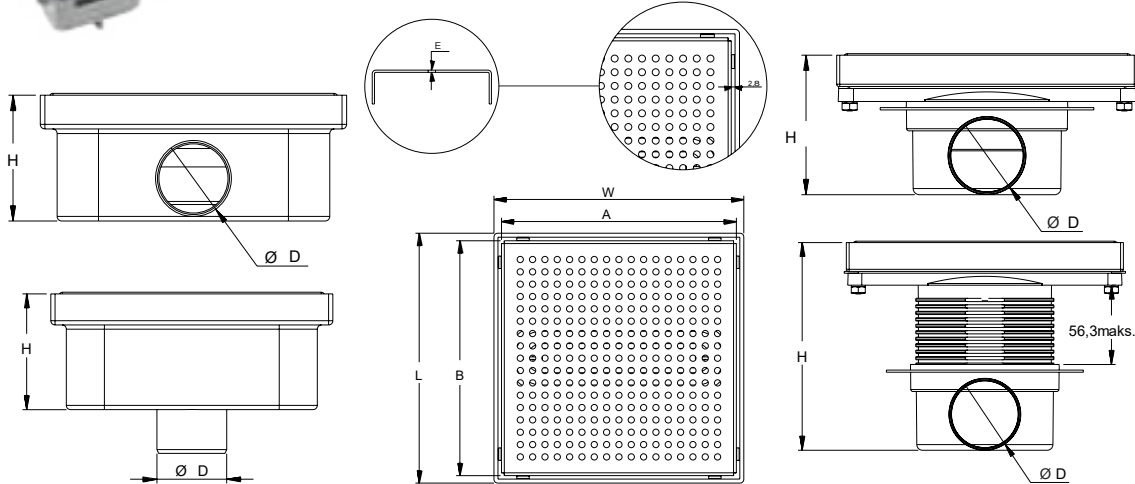

ÜRÜN KODU	W	L	H	Ø D	A	B	E
4072.0Y050K.020.0	200	200	82	49.5	188	188	1.5
ÜRÜN KODU	W	L	H	Ø D	A	B	E
4072.0A050K.020.0	200	200	82	49.5	188	188	1.5

LINE

Ürün Kodu	Kısa Kod	Çıkış	Ölçü	Fiyat
YAN ÇIKIŞ				
4072.0Y050K.020.1	18154	Ø 50	20x20 cm	676.70
ALT ÇIKIŞ				
4072.0A050K.020.1	18156	Ø 50	20x20 cm	676.70

Duş kanalı / 200x200 mm / Ø 50 yan - alt çıkış
Plastik gövde / Paslanmaz ızgara / Sulu koku tutucu

LEGAL

Ürün Kodu	Kısa Kod	Çıkış	Ölçü	Fiyat
YAN ÇIKIŞ				
4073.0Y050K.020.1	18160	Ø 50	20x20 cm	1203.40
ALT ÇIKIŞ				
4073.0A050K.020.1	18164	Ø 50	20x20 cm	1203.40

Duş kanalı / 200x200 mm / Ø 50 yan - alt çıkış
Paslanmaz gövde / Paslanmaz ızgara / Sulu koku tutucu

LEGAL Y360°

Ürün Kodu	Kısa Kod	Çıkış	Ölçü	Fiyat
YAN ÇIKIŞ				
4073.0Y360K.020.1	18176	Ø 50	20x20 cm	1290.00
ALT ÇIKIŞ				
4073.0A360K.020.1	31400	Ø 50	20x20 cm	1290.00

Duş kanalı / 200x200 mm / Ø 50 yan - alt çıkış
Paslanmaz gövde / Paslanmaz ızgara / Sulu koku tutucu

DOLU

KARE

LINE



HM-31361
Uzun koku tutucu kullanılmaktadır.

Ürün Kodu	Kısa Kod	Çıkış	Ölçü		Fiyat
YAN ÇIKIŞ					
4062.0Y050K.033.1	18117	Ø 50	33 cm	12	640.00
ALT ÇIKIŞ					
4062.0A050K.033.1	18121	Ø 50	33 cm	12	640.00

Duş kanalı / 200x200 mm / Ø 50 yan - alt çıkış
Plastik gövde / Paslanmaz ızgara / Sulu koku tutucu

LEGAL



HM-31363
Legal koku tutucu kullanılmaktadır.

Ürün Kodu	Kısa Kod	Çıkış	Ölçü		Fiyat
YAN ÇIKIŞ					
4063.0Y050K.033.1	18137	Ø 50	33 cm	12	1116.70
ALT ÇIKIŞ					
4063.0A050K.033.1	18140	Ø 50	33 cm	12	1116.70

Duş kanalı / 200x200 mm / Ø 50 yan - alt çıkış
Paslanmaz gövde / Paslanmaz ızgara / Sulu koku tutucu

LEGAL Y360°



HM-31363
Legal koku tutucu kullanılmaktadır.

Ürün Kodu	Kısa Kod	Çıkış	Ölçü		Fiyat
YAN ÇIKIŞ					
4063.0Y360K.033.1	18150	Ø 50	33 cm	12	1203.40
ALT ÇIKIŞ					
4063.0A360K.033.1	31401	Ø 50	33 cm	12	1203.40

Duş kanalı / 200x200 mm / Ø 50 yan - alt çıkış
Paslanmaz gövde / Paslanmaz ızgara / Sulu koku tutucu

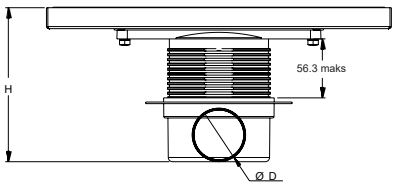
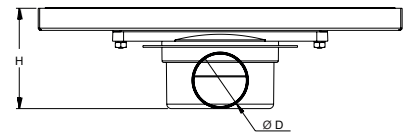
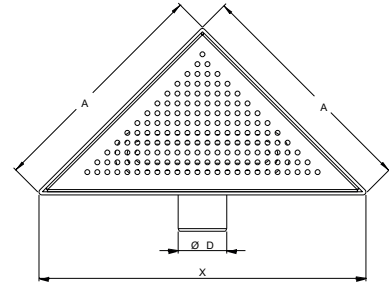
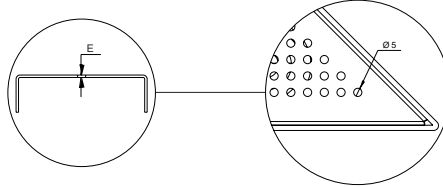
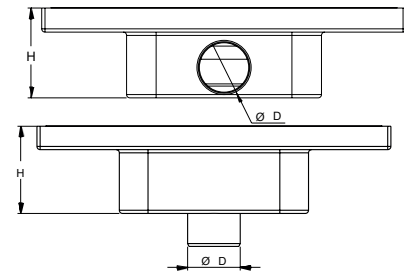

ÜRÜN KODU	H	Ø D	A	X	E
4062.0Y050K.033.0	84	49.5	234	330	1.5

ÜRÜN KODU	H	Ø D	A	X	E
4062.0A050K.033.0	84	49.5	234	330	1.5

ÜRÜN KODU	H	Ø D	A	X	E
4063.00360K.033.0	91	49.5	234	330	1.5

ÜRÜN KODU	H	Ø D	A	X	E
4063.0Y360K.033.0	147	49.5	234	330	1.5

Tablo ölçü birimi "mm"dir.



DOLU



KARE

KANAL OLUĞU 100x500 mm

Ürün Kodu	Kısa Kod	Ölçü	Yükseklik	Fiyat
BEYAZ				
7010.05005Y.0.0	13659	100x500 mm	50 mm	40 126.70
7011.05005A.0.0	13660	100x500 mm A.Ç. Ø 50	50 mm	32 136.70
SİYAH				
7010.05005Y.0.S	26863	100x500 mm	50 mm	40 126.70
7011.05005A.0.S	26864	100x500 mm A.Ç. Ø 50	50 mm	32 136.70

PLASTİK KANAL IZGARASI 100x500mm

Ürün Kodu	Kısa Kod	Ölçü	Yükseklik	Fiyat
BEYAZ				
7110.050120.0.0	13653	100x500 mm	-	40 96.70
SİYAH				
7110.050120.0.S	26865	100x500 mm	-	40 96.70

PASLANMAZ KANAL IZGARASI 100x500 mm

Ürün Kodu	Kısa Kod	Ölçü	Kalite	Desen	Fiyat
2110.05012P304.2	13745	100x500 mm	S.S.304	Kare	10 590.00
2110.10012P304.2	13780	100x1000 mm	S.S.304	Kare	10 1173.40
2110.05012G.430.1	13749	100x500 mm	Galvaniz	Kare	10 250.00
2110.05012G.430.2	13784	100x1000 mm	Galvaniz	Kare	10 490.00

KANAL TAPASI 100 mm

Ürün Kodu	Kısa Kod	Ölçü	Açıklama	Fiyat
BEYAZ				
7210.00050Y.0.0	13667	80x63 mm	Erkek tapa çıkışlı	150 15.00
7217.00050Y.0.0	34900	80x63 mm	Dişi tapa	150 15.00
7218.00050Y.0.0	34901	80x63 mm	Dişi tapa çıkışlı	150 15.00
SİYAH				
7210.00050Y.0.S	26866	80x63 mm	Erkek tapa çıkışlı	150 15.00
7217.00050Y.0.S	34902	80x63 mm	Dişi tapa	150 15.00
7218.00050Y.0.S	34903	80x63 mm	Dişi tapa çıkışlı	150 15.00



• Plastik gövde



• Plastik gövde



• Paslanmaz Izgara



7210.00050Y.0.0 7217.00050Y.0.0 7218.00050Y.0.0



7210.00050Y.0.S 7217.00050Y.0.S 7218.00050Y.0.S

• Plastik gövde
• Ø 32 çıkış

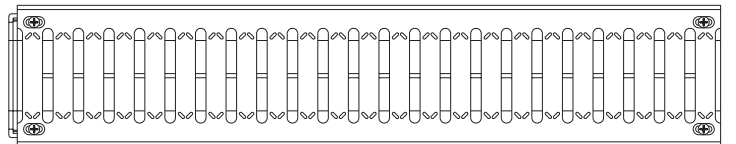
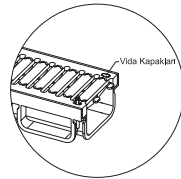
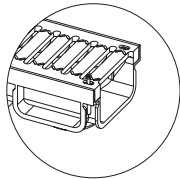
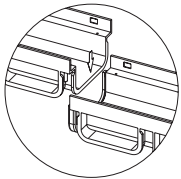



• Polypropylene



• Polypropylene



• Paslanmaz



• PİK Döküm



7212.00070Y.0.0 7227.00070Y.0.0 7228.00070Y.0.0



7212.00070Y.0.S 7227.00070Y.0.S 7228.00070Y.0.S

• Polypropylene
• Ø 50 çıkış

KANAL OLUĞU 130x500 mm

Ürün Kodu	Kısa Kod	Ölçü	Yükseklik	Çıkış	Fiyat
BEYAZ					
7013.05008Y.0.0	13661	130x500 mm	75 mm	-	40 156.70
7014.05008A.0.0	13662	130x500 mm A.Ç.	75 mm	Ø 50 / 70	32 166.70
SİYAH					
7013.05008Y.0.0	25118	130x500 mm	75 mm	-	40 156.70
7014.05008A.0.0	25119	130x500 mm A.Ç.	75 mm	Ø 50 / 70	32 166.70

PLASTİK KANAL IZGARASI 130x500mm

Ürün Kodu	Kısa Kod	Ölçü	Yükseklik	Fiyat
BEYAZ				
7113.050200.0.0	13655	130x500 mm	-	40 146.70
SİYAH				
7113.050200.0.S	25120	130x500 mm	-	40 146.70

PASLANMAZ KANAL IZGARASI

Ürün Kodu	Kısa Kod	Ölçü	Kalite	Desen	Fiyat
130x500 MM					
2113.05020P.304.2	13811	130x500 mm	S.S.304	Kare	10 760.00
2113.05020P.304.4	13788	130x500 mm	S.S.304	Standart	10 626.70
130x1000 MM					
2113.10020P.304.2	13833	130x1000 mm	S.S.304	Kare	10 1513.40
2113.10020P.304.4	13821	130x1000 mm	S.S.304	Standart	10 1243.40
GALVANİZ					
2113.05020P.430.4	13797	130x500 mm	Galvaniz	Standart	10 266.70
2113.10021P.430.4	13825	130x1000 mm	Galvaniz	Standart	10 523.40

SFERO DÖKÜM KANAL IZGARASI 130x500mm

Ürün Kodu	Kısa Kod	Ölçü	Desen	Fiyat
2113.05020D.000.4	18172	130x500 mm	Standart	5 1300.00

KANAL TAPASI 130 mm

Ürün Kodu	Kısa Kod	Ölçü	Açıklama	Fiyat
BEYAZ				
7212.00070Y.0.0	13668	125x75 mm	Erkek tapa çıkışlı	150 50.00
7227.00070Y.0.0	13669	125x75 mm	Dişi tapa	150 50.00
7228.00070Y.0.0	13670	125x75 mm	Dişi tapa çıkışlı	150 50.00
SİYAH				
7212.00070Y.0.S	26104	125x75 mm	Erkek tapa çıkışlı	150 50.00
7227.00070Y.0.S	27108	125x75 mm	Dişi tapa	150 50.00
7228.00070Y.0.S	27109	125x75 mm	Dişi tapa çıkışlı	150 50.00

DRENAJ KANALLARI

MAXIFLOW
Maksimum akış...

KANAL OLUĞU 130x1000 mm

Ürün Kodu	Kısa Kod	Ölçü	Yükseklik	Çıkış		Fiyat
BEYAZ						
7015.10010Y.0.0	13663	130x1000 mm	100 mm	-	20	353.40
7016.10010A.0.0	13664	130x1000 mm A.Ç.	100 mm	Ø 50 / 70	16	380.00
SİYAH						
7015.10010Y.0.S	27104	130x1000 mm	100 mm	-	20	353.40
7016.10010A.0.S	27105	130x1000mmA.Ç.	100 mm	Ø 50 / 70	16	380.00



• Polypropylene

PLASTİK KANAL IZGARASI 130x500mm

Ürün Kodu	Kısa Kod	Ölçü	Yükseklik		Fiyat
BEYAZ					
7113.050200.0.0	13655	130x500 mm	-	40	146.70
SİYAH					
7113.050200.0.S	25120	130x500 mm	-	40	146.70

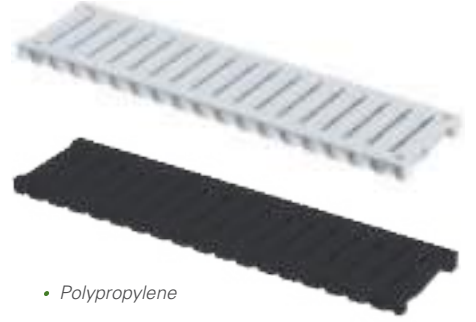

• Polypropylene

KANAL TAPASI 130 mm

Ürün Kodu	Kısa Kod	Ölçü	Açıklama		Fiyat
BEYAZ					
7213.00100Y.0.B	13671	125x100 mm	Erkek tapa çıkışlı	150	50.00
7230.00100Y.0.B	13672	125x100 mm	Dişi tapa	150	50.00
7231.00100Y.0.B	13673	125x100 mm	Dişi tapa çıkışlı	150	50.00
SİYAH					
7213.00100Y.0.S	27112	125x100 mm	Erkek tapa çıkışlı	150	50.00
7230.00100Y.0.S	27110	125x100 mm	Dişi tapa	150	50.00
7231.00100Y.0.S	27111	125x100 mm	Dişi tapa çıkışlı	150	50.00



• Polypropylene
• Ø 50-70 çıkış

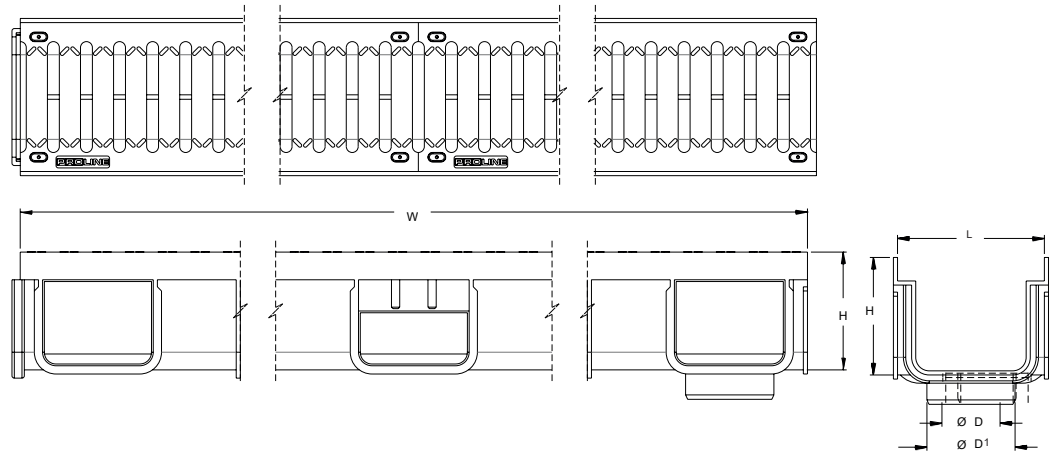
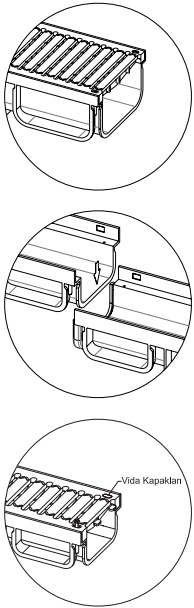

IZGARA DESEN SEÇENEKLERİ

ÜRÜN KODU	W	L	H	Ø D	Ø D1
7015.10010Y.0.0	1000	125	75	-	-
7016.10010A.0.0	1000	125	75	49.5	74.5



PLASTİK



KARE

• PP
• AISI 304
• AISI 430
• Galvaniz
• Stero Döküm

• AISI 304
• AISI 430
• Galvaniz

KANAL OLUĞU 130x1000 mm



Ürün Kodu	Kısa Kod	Ölçü	Yükseklik	Çıkış		Fiyat
BEYAZ						
7017.10008A.0.0	30890	130x1000 mm	75 mm	Ø 50 / 70 / 100	20	340.00
SİYAH						
7317.10008A.0.S	30891	130x1000 mm	75 mm	Ø 50 / 70 / 100	20	340.00

PLASTİK KANAL IZGARASI 130x1000mm



Ürün Kodu	Kısa Kod	Ölçü	Yükseklik		Fiyat
BEYAZ					
7114.100120.0.0	30892	130x1000 mm	-	20	310.00
SİYAH					
7414.100120.0.S	30893	130x1000 mm	-	20	310.00

KANAL TAPASI 130 mm



7212.00070Y.0.0 7227.00070Y.0.0 7228.00070Y.0.0

7212.00070Y.0.S 7227.00070Y.0.S 7228.00070Y.0.S

- Polypropylene
- Ø 50 çıkış

Ürün Kodu	Kısa Kod	Ölçü	Açıklama		Fiyat
BEYAZ					
7212.00070Y.0.0	13668	125x75 mm	Erkek tapa çıkışlı	150	50.00
7227.00070Y.0.0	13669	125x75 mm	Dişi tapa	150	50.00
7228.00070Y.0.0	13670	125x75 mm	Dişi tapa çıkışlı	150	50.00
SİYAH					
7212.00070Y.0.S	26104	125x75 mm	Erkek tapa çıkışlı	150	50.00
7227.00070Y.0.S	27108	125x75 mm	Dişi tapa	150	50.00
7228.00070Y.0.S	27109	125x75 mm	Dişi tapa çıkışlı	150	50.00

IZGARA DESEN SEÇENEKLERİ



PLASTİK

KARE

- PP
- AISI 304
- AISI 430
- Galvaniz
- Sfere Döküm

- AISI 304
- AISI 430
- Galvaniz

ÜRÜN KODU	W	L	H	Ø D	Ø D1
7015.10010Y.0.0	1000	125	75	-	-
7016.10010A.0.0	1000	125	75	49.5	74.5

KANAL OLUĞU 200x500 mm

Ürün Kodu	Kısa Kod	Ölçü	Yükseklik	Fiyat
BEYAZ				
7020.05013Y.0.0	13665	200x500 mm	120 mm	300.00
7021.05013A.0.0	13666	200x500 mm A.Ç. Ø 70 / 100	120 mm	313.40
SİYAH				
7020.05013Y.0.S	26920	200x500 mm	120 mm	300.00
7021.05013A.0.S	26921	200x500 mm A.Ç. Ø 70 / 100	120 mm	313.40



• Polypropylene

PLASTİK KANAL IZGARASI 200x500mm

Ürün Kodu	Kısa Kod	Ölçü	Yükseklik	Fiyat
BEYAZ				
7120.050200.0.0	13657	200x500 mm	-	246.70
SİYAH				
7120.050200.0.S	26922	200x500 mm	-	246.70

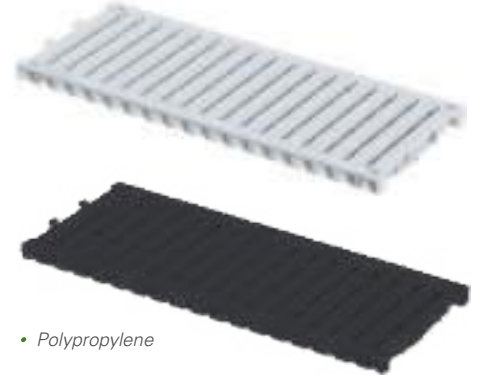

• Polypropylene

PASLANMAZ KANAL IZGARASI 200x500mm

Ürün Kodu	Kısa Kod	Ölçü	Kalite	Desen	Fiyat
2120.05021P.304.2	13861	200x500 mm	S.S.304	Kare	1383.40
2120.05021P.304.3	13851	200x500 mm	S.S.304	Çizgi	1383.40
2120.05021P.304.4	13840	200x500 mm	S.S.304	Standart	1400.00
2120.05021P.430.4	13849	200x500 mm	GALVANİZ	Standart	556.70



• Paslanmaz

SFERO DÖKÜM KANAL IZGARASI 200x500mm

Ürün Kodu	Kısa Kod	Ölçü	Kalite	Desen	Fiyat
2120.05020D.000.4	18181	200x500 mm	Sfero Döküm	Standart	1893.40



• Pik Döküm

KANAL TAPASI 200 mm

Ürün Kodu	Kısa Kod	Ölçü	Açıklama	Fiyat
BEYAZ				
7220.00120Y.0.0	13674	200x120 mm	Erkek tapa çıkışlı	50.00
7247.00120Y.0.0	34904	200x120 mm	Dişi tapa	50.00
7248.00120Y.0.0	34905	200x120 mm	Dişi tapa çıkışlı	50.00
SİYAH				
7220.00120Y.0.S	27083	200x120 mm	Erkek tapa çıkışlı	50.00
7247.00120Y.0.S	34906	200x120 mm	Dişi tapa	50.00
7248.00120Y.0.S	34907	200x120 mm	Dişi tapa çıkışlı	50.00



• Polypropylene
• Ø 70 çıkış

RÖGAR KAPAK TAKIMI

- Plastik gövde
- Plastik çerçeve

Ürün Kodu	Kısa Kod	Ölçü	Fiyat
2601.222200.141.T	13758	22x22 cm	183.40
2601.333300.142.T	13760	33x33 cm	313.40
2601.393900.146.T	13763	39x39 cm	573.40



- Paslanmaz gövde
- Paslanmaz çerçeve

PASLANMAZ RÖGAR KAPAK TAKIMI

Ürün Kodu	Kısa Kod	Ölçü	Fiyat
2603.2020A0.050.P	34877	20x20 cm	3133.40
2603.3030A0.050.P	32697	30x30 cm	4760.00
2603.4040A0.050.P	32525	40x40 cm	6816.70
2603.5050A0.050.P	32526	50x50 cm	9373.40
2603.6060A0.050.P	32527	60x60 cm	12386.70



100 MM FUGA CENTRE

Ürün Kodu	Kısa Kod	Ölçü		Fiyat
100x500 MM				
3110.05050P304.9	34373	100x500 mm	5	1656.70
100x1000 MM				
3110.10050P304.9	34374	100x1000 mm	5	2643.40



• Paslanmaz gövde

130 MM FUGA CENTRE

Ürün Kodu	Kısa Kod	Ölçü		Fiyat
100x500 MM				
3113.05050P304.9	34375	130x500 mm	5	2123.40
100x1000 MM				
3113.10050P304.9	34376	130x1000 mm	5	3400.00



• Paslanmaz gövde

200 MM FUGA CENTRE

Ürün Kodu	Kısa Kod	Ölçü		Fiyat
100x500 MM				
3120.05050P304.9	34377	200x500 mm	5	3283.40
100x1000 MM				
3120.10050P304.9	34378	200x1000 mm	5	5223.40



• Paslanmaz gövde

UYGULAMA ÖRNEKLERİ



Plastik Drenaj Kanalı



Polimer Drenaj Kanalı



Plastik Drenaj Kanalı



Polimer Drenaj Kanalı

AISI 304 - 430 ve Galvaniz malzemeden istenilen özel ölçülerde üretim yapılabilmektedir. Tüm plastik ve polimer drenaj kanalları ile uyumludur.

AISI 304 - 430 ve Galvaniz malzemeden istenilen özel ölçülerde üretim yapılabilmektedir. Tüm plastik ve polimer drenaj kanalları ile uyumludur.



• Paslanmaz gövde

100 MM FUGA CORNER

Ürün Kodu	Kısa Kod	Ölçü	Fiyat
100x500 MM			
3110.05050P304.8	34379	100x500 mm	1656.70
100x1000 MM			
3110.10050P304.8	34380	100x1000 mm	2643.40



• Paslanmaz gövde

130 MM FUGA CORNER

Ürün Kodu	Kısa Kod	Ölçü	Fiyat
100x500 MM			
3113.05050P304.8	34381	130x500 mm	2123.40
100x1000 MM			
3113.10050P304.8	34382	130x1000 mm	3400.00



• Paslanmaz gövde

200 MM FUGA CORNER

Ürün Kodu	Kısa Kod	Ölçü	Fiyat
100x500 MM			
3120.05050P304.8	34383	200x500 mm	3283.40
100x1000 MM			
3120.10050P304.8	34384	200x1000 mm	5223.40

20x20 ÇAMUR SIFON

Ürün Kodu	Kısa Kod	Çıkış	Ölçü	Fiyat
YAN ÇIKIŞ				
1101.2020Y0.070.0	13748	Ø 70	20x20 cm	273.40
ALT ÇIKIŞ				
1101.2020A0.070.0	13750	Ø 70	20x20 cm	256.70



- Ø 70 yan - alt çıkış
- Plastik gövde
- Plastik ızgara

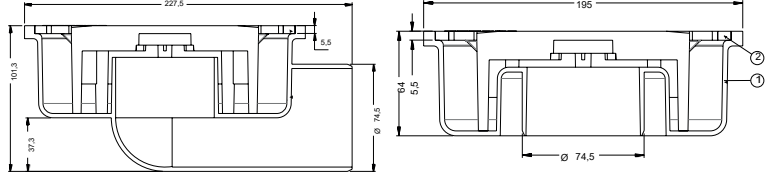

25x25 ÇAMUR SIFON

Ürün Kodu	Kısa Kod	Çıkış	Ölçü	Fiyat
YAN ÇIKIŞ				
1101.2525Y0.100.0	13755	Ø 100	25x25 cm	386.70
ALT ÇIKIŞ				
1101.2525A0.100.0	13756	Ø 100	25x25 cm	373.40



- Ø 100 yan - alt çıkış
- Plastik gövde
- Plastik ızgara

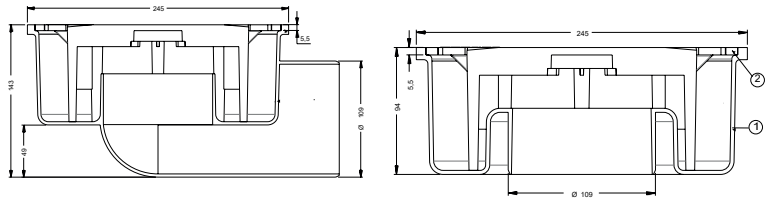

ENGELLİ SERİSİ

TUTUNMA BARI Ø 19

Ürün Kodu	Kısa Kod	Ölçü	Kalite		Fiyat
4819.1920P304.00	13549	8.5x20 cm	S.S. 304	10	353.40
4819.1930P304.00	13556	8.5x30 cm	S.S. 304	10	380.00
4819.1940P304.00	13557	8.5x40 cm	S.S. 304	10	406.70
4819.1950P304.00	13559	8.5x50 cm	S.S. 304	10	433.40
4819.1960P304.00	13560	8.5x60 cm	S.S. 304	10	460.00

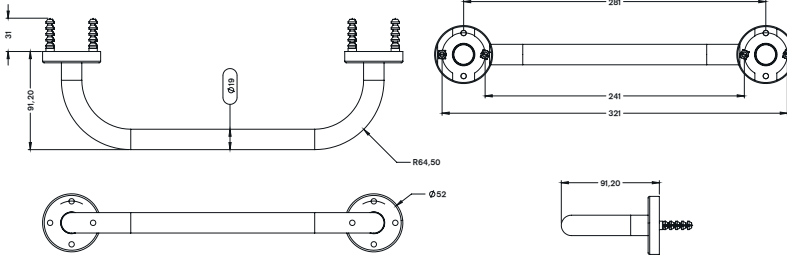

TUTUNMA BARI Ø 25

Ürün Kodu	Kısa Kod	Ölçü	Kalite		Fiyat
4819.2520P304.00	13561	8.5x20 cm	S.S. 304	10	413.40
4819.2530P304.00	13562	8.5x30 cm	S.S. 304	10	456.70
4819.2540P304.00	13563	8.5x40 cm	S.S. 304	10	500.00
4819.2550P304.00	13564	8.5x50 cm	S.S. 304	10	540.00
4819.2560P304.00	13565	8.5x60 cm	S.S. 304	10	583.40

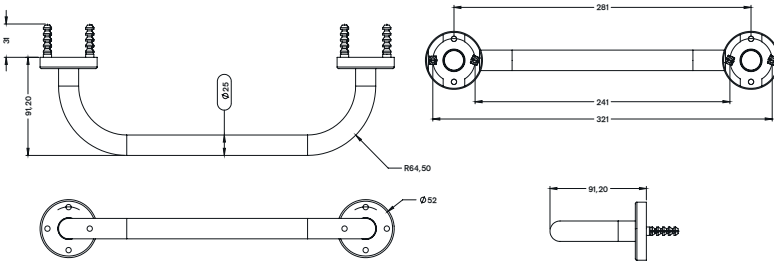

TUTUNMA BARI Ø 32

Ürün Kodu	Kısa Kod	Ölçü	Kalite		Fiyat
4819.3230P304.00	13566	10.5x30 cm	S.S. 304	10	610.00
4819.3240P304.00	13567	10.5x40 cm	S.S. 304	10	666.70
4819.3250P304.00	13568	10.5x50 cm	S.S. 304	10	720.00
4819.3260P304.00	13569	10.5x60 cm	S.S. 304	10	776.70

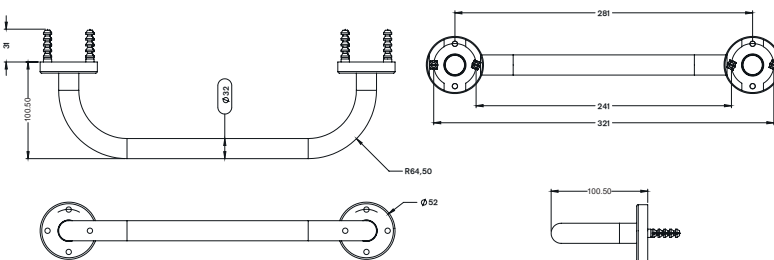

AÇILI TUTUNMA BARI



Ürün Kodu	Kısa Kod	Çap	Ölçü	Kalite	Fiyat
4826.1950P304.00	13570	Ø 19	13x40x8.5 cm	S.S. 304	433.40
4826.2564P304.00	13571	Ø 25	13x44x8.5 cm	S.S. 304	550.00
4826.3264P304.00	13572	Ø 32	22x64x10 cm	S.S. 304	836.70

AÇILI SÜNGERLİ TUTUNMA BARI



Ürün Kodu	Kısa Kod	Çap	Ölçü	Kalite	Fiyat
4827.1950P304.00	13573	Ø 19	13x40x10 cm	S.S. 304	756.70
4827.2550P304.00	13574	Ø 25	13x44x10 cm	S.S. 304	866.70

LAVABO TUTUNMA BARI



Ürün Kodu	Kısa Kod	Çap	Ölçü	Kalite	Fiyat
4838.7080P304.00	13575	Ø 32	76x74x80 cm	S.S. 304	5310.00

MAFSALLI AYAKLI



Ürün Kodu	Kısa Kod	Çap	Ölçü	Kalite	Fiyat
4828.7611P304.00	13576	Ø 32	75x73 cm	S.S. 304	4473.40

MAFSALLI STANDART

Ürün Kodu	Kısa Kod	Çap	Ölçü	Kalite	Fiyat
SS 304					
4832.2311P.304.00	13578	Ø 32	73x24x11 cm	SS 304	5 1756.70
RENKLİ					
4832.2311B.101.00	28808	Ø 32	73x24x11 cm	BEYAZ	5 1303.40
4832.2311S.102.00	28809	Ø 32	73x24x11 cm	SIYAH	5 1303.40

• Tutunma barı

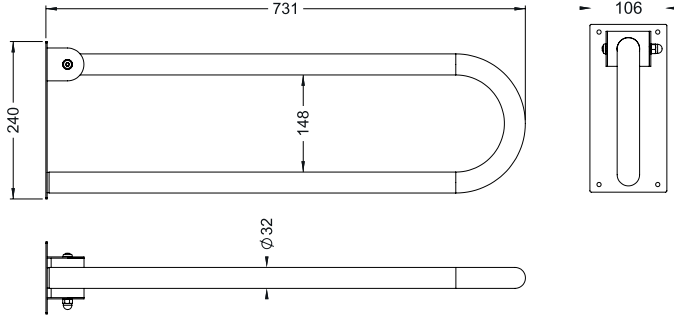

MAFSALLI WC KAĞITLIKLİ

Ürün Kodu	Kısa Kod	Çap	Ölçü	Kalite	Fiyat
SS 304					
4833.2311P.304.00	13579	Ø 32	73x24x11 cm	SS 304	5 1943.40
RENKLİ					
4833.2311B.101.00	28810	Ø 32	73x24x11 cm	BEYAZ	5 1446.70
4833.2311S.102.00	28811	Ø 32	73x24x11 cm	SIYAH	5 1446.70

• Tutunma barı

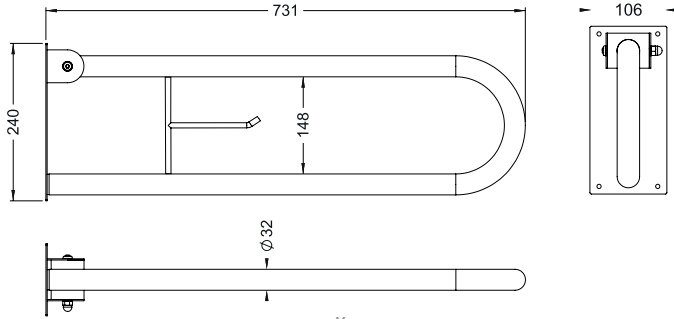

MAFSALLI WC KAĞITLIKLİ

Ürün Kodu	Kısa Kod	Çap	Ölçü	Kalite	Fiyat
SS 304					
4835.2311P.304.00	13580	Ø 32	73x24x11 cm	SS 304	5 1996.70
RENKLİ					
4835.2311B.101.00	28812	Ø 32	73x24x11 cm	BEYAZ	5 1493.40
4835.2311S.102.00	28813	Ø 32	73x24x11 cm	SIYAH	5 1493.40

• Tutunma barı

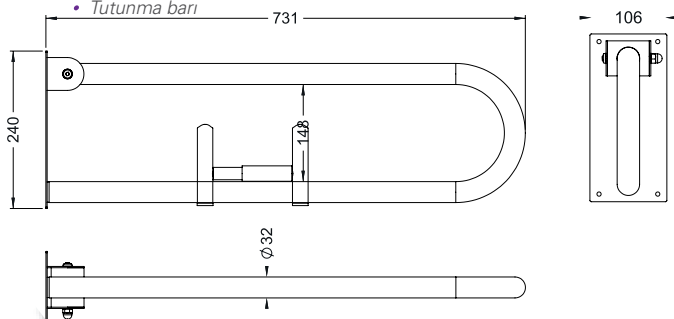



YERDEN DUVARA

Ürün Kodu	Kısa Kod	Çap	Ölçü	Kalite	Fiyat
SS 304					
4834.7500P.304.00	13581	Ø 32	75x75 cm	SS 304	5
					1220.00

• Tutunma barı

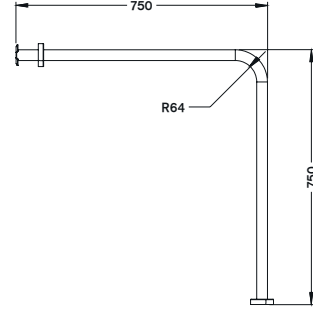

YERDEN DUVARA BASTON AYAK

Ürün Kodu	Kısa Kod	Çap	Ölçü	Kalite	Fiyat
SS 304					
4836.7500P.304.00	13582	Ø 32	75x75x30 cm	SS 304	5
					1593.40

• Tutunma barı

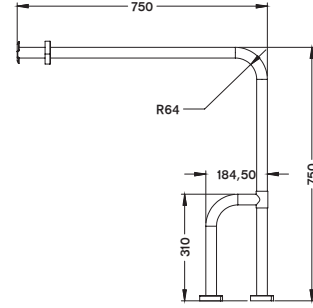

AÇILI TUTUNMA BARI KÖŞE

Ürün Kodu	Kısa Kod	Çap	Ölçü	Kalite	Fiyat
SS 304					
4831.4012P.304.00	13583	Ø 32	80x40x12 cm	SS 304	5
					1483.40

• Tutunma barı

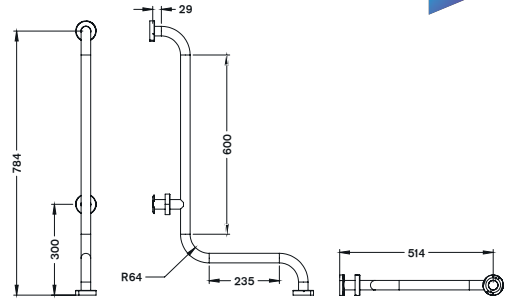

L TİPİ TUTUNMA BARI

Ürün Kodu	Kısa Kod	Çap	Ölçü	Kalite	Fiyat
SS 304					
4837.4012P.304.00	13584	Ø 32	80x40x12 cm	SS 304	5
					1483.40

• Tutunma barı

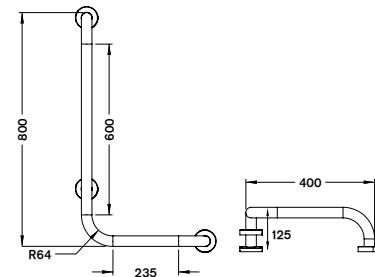

PLASTİK ENGELLİ DUŞ OTURAĞI



Ürün Kodu	Kısa Kod	Çap	Ölçü	Kalite	Fiyat
SS 304					
4820.4043S.304.00	13585	Ø 19	43x41.5x39.5 cm	SS 304 5	2333.40

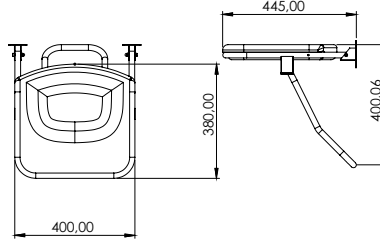

AHŞAP ENGELLİ DUŞ OTURAĞI



Ürün Kodu	Kısa Kod	Çap	Ölçü	Kalite	Fiyat
SS 304					
4820.4041S.304.00	13586	Ø 19	46x43.5x39 cm	SS 304 5	3386.70

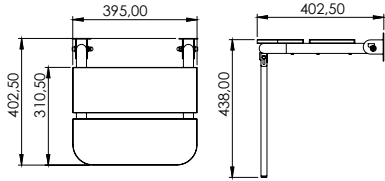

ENGELLİ AYNASI



Ürün Kodu	Kısa Kod	Ölçü	Kalite	Fiyat
SS 304				
4821.5070S.304.00	13587	50x70 cm	SS 304 5	2246.70

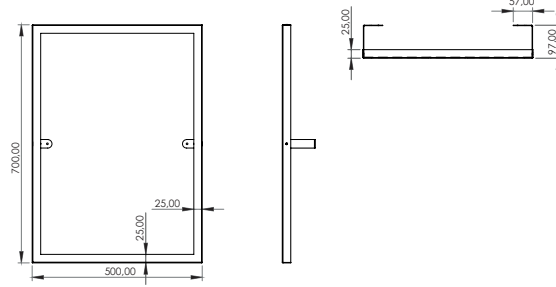

KULPLU ENGELLİ AYNASI



Ürün Kodu	Kısa Kod	Ölçü	Kalite	Fiyat
SS 304				
4840.5070S.304.00	13588	50x70 cm	SS 304 5	2293.40

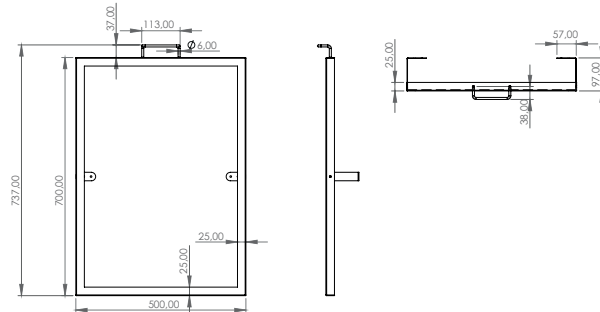

ÇÖP KOVALARI



PEDALLI ÇÖP KOVALARI

MAXIFLOW
Maksimum akış...

MICRO

Ürün Kodu	Kısa Kod	Çap	Yükseklik	Kalite	İkisi	Fiyat
SS 430						
4501.1725M.430.03	13210	3 L Ø 17	24 cm	S.S. 430	8	463.40
4501.1825M.430.05	13212	5 L Ø 21	22 cm	S.S. 430	8	540.00



- Paslanmaz gövde
- Pedallı

STANDART PEDALLI ÇÖP KOVASI

Ürün Kodu	Kısa Kod	Çap	Yükseklik	Kalite	İkisi	Fiyat
SS 430						
4501.1825S.430.03	13231	3 L Ø 21	22 cm	S.S. 430	8	540.00
4501.2028S.430.05	13234	5 L Ø 21	26 cm	S.S. 430	8	593.40
4501.2035S.430.08	13235	8 L Ø 21	35 cm	S.S. 430	6	780.00
4501.2435S.430.12	13236	12 L Ø 25	35 cm	S.S. 430	6	883.40
4501.2444S.430.16	13237	16 L Ø 25	44 cm	S.S. 430	4	1193.40
4501.3135S.430.20	13238	20 L Ø 31	36 cm	S.S. 430	4	1520.00
4501.3144S.430.30	13239	30 L Ø 31	45 cm	S.S. 430	4	1640.00
4501.3163S.430.40	13240	40 L Ø 31	63 cm	S.S. 430	4	2106.70
SS 304						
4501.1825S.304.03	13241	3 L Ø 21	22 cm	S.S. 304	8	760.00
4501.2028S.304.05	13242	5 L Ø 21	26 cm	S.S. 304	8	810.00
4501.2035S.304.08	13243	8 L Ø 21	35 cm	S.S. 304	6	1046.70
4501.2435S.304.12	13248	12 L Ø 25	35 cm	S.S. 304	6	1210.00



- Paslanmaz gövde
- Pedallı

STANDART BOYALI ÇÖP KOVASI

Ürün Kodu	Kısa Kod	Çap	Yükseklik	İkisi	Fiyat
BEYAZ					
4501.1825S.101.03	18199	3 L Ø 21	22 cm	8	580.00
4501.2028S.101.05	18204	5 L Ø 21	26 cm	8	606.70
4501.2035S.101.08	19855	8 L Ø 21	35 cm	6	820.00
4501.2435S.101.12	18208	12 L Ø 25	35 cm	6	933.40
4501.2444S.101.16	27520	16 L Ø 25	44 cm	4	1220.00
4501.3135S.101.20	26002	20 L Ø 31	36 cm	4	1483.40
4501.3144S.101.30	27526	30 L Ø 31	45 cm	4	1590.00
4501.3163S.101.40	27532	40 L Ø 31	63 cm	4	1990.00
SİYAH					
4501.1825S.102.03	18197	3 L Ø 21	22 cm	8	580.00
4501.2028S.102.05	18202	5 L Ø 21	26 cm	8	606.70
4501.2035S.102.08	19858	8 L Ø 21	35 cm	6	820.00
4501.2435S.102.12	18207	12 L Ø 25	35 cm	6	933.40
4501.2444S.102.16	27523	16 L Ø 25	44 cm	4	1220.00
4501.3135S.102.20	26005	20 L Ø 31	36 cm	4	1483.40
4501.3144S.102.30	27528	30 L Ø 31	45 cm	4	1590.00
4501.3163S.102.40	27534	40 L Ø 31	63 cm	4	1990.00





- Paslanmaz gövde
- Pedalli

AMORTİSÖRLÜ KAPAK

Ürün Kodu	Kısa Kod	Çap	Yükseklik	Kalite	Fiyat
SS 430					
4501.1825Y.430.03	13249 3 L	Ø 21	22 cm	S.S. 430 8	636.70
4501.2028Y.430.05	13250 5 L	Ø 21	26 cm	S.S. 430 8	673.40
4501.2035Y.430.08	13254 8 L	Ø 21	35 cm	S.S. 430 6	870.00
4501.2435Y.430.12	13255 12 L	Ø 25	35 cm	S.S. 430 6	976.70
4501.2444Y.430.16	13268 16 L	Ø 25	44 cm	S.S. 430 4	1296.70
4501.3135Y.430.20	21355 20 L	Ø 31	36 cm	S.S. 430 4	1643.40
4501.3144Y.430.30	21356 30 L	Ø 31	45 cm	S.S. 430 4	1770.00
4501.3163Y.430.40	21357 40 L	Ø 31	63 cm	S.S. 430 4	2253.40
SS 304					
4501.1825Y.304.03	13256 3 L	Ø 21	22 cm	S.S. 304 8	900.00
4501.2028Y.304.05	13260 5 L	Ø 21	26 cm	S.S. 304 8	953.40
4501.2035Y.304.08	13261 8 L	Ø 21	35 cm	S.S. 304 6	1200.00
4501.2435Y.304.12	13262 12 L	Ø 25	35 cm	S.S. 304 6	1370.00

BOMBE KAPAK

Ürün Kodu	Kısa Kod	Çap	Yükseklik	Kalite	Fiyat
SS 430					
4516.1825S.430.03	30816 3 L	Ø 21	21 cm	S.S. 430 8	626.70
4516.2028S.430.05	30817 5 L	Ø 21	27 cm	S.S. 430 8	663.40
4516.2035S.430.08	30818 8 L	Ø 21	36 cm	S.S. 430 6	866.70
4516.2435S.430.12	30819 12 L	Ø 25	36 cm	S.S. 430 6	983.40
4516.2444S.430.16	30820 16 L	Ø 25	45 cm	S.S. 430 4	1333.40
4516.3135S.430.20	30821 20 L	Ø 31	37 cm	S.S. 430 4	1740.00
4516.3144S.430.30	30822 30 L	Ø 31	46 cm	S.S. 430 4	1870.00
4516.3163S.430.40	30823 40 L	Ø 31	64 cm	S.S. 430 4	2353.40
BEYAZ					
4516.1825S.101.03	30824 3 L	Ø 21	21 cm	8	603.40
4516.2028S.101.05	30825 5 L	Ø 21	27 cm	8	633.40
4516.2035S.101.08	30826 8 L	Ø 21	36 cm	6	820.00
4516.2435S.101.12	30827 12 L	Ø 25	36 cm	6	933.40
4516.2444S.101.16	30828 16 L	Ø 25	45 cm	4	1220.00
4516.3135S.101.20	30829 20 L	Ø 31	37 cm	4	1613.40
4516.3144S.101.30	30830 30 L	Ø 31	46 cm	4	1716.70
4516.3163S.101.40	30831 40 L	Ø 31	64 cm	4	2133.40
SİYAH					
4516.1825S.102.03	30832 3 L	Ø 21	21 cm	8	603.40
4516.2028S.102.05	30833 5 L	Ø 21	27 cm	8	633.40
4516.2035S.102.08	30834 8 L	Ø 21	36 cm	6	820.00
4516.2435S.102.12	30835 12 L	Ø 25	36 cm	6	933.40
4516.2444S.102.16	30836 16 L	Ø 25	45 cm	4	1220.00
4516.3135S.102.20	30837 20 L	Ø 31	37 cm	4	1613.40
4516.3144S.102.30	30838 30 L	Ø 31	46 cm	4	1716.70
4516.3163S.102.40	30839 40 L	Ø 31	64 cm	4	2133.40



- Paslanmaz gövde
- Pedalli



PRATİK KAPAK

Ürün Kodu	Kısa Kod	Çap	Yükseklik	Kalite	Fiyat
SS 430					
4513.0000S.430.05	13269	5 L Ø 21	26 cm	S.S. 430 8	853.40
4513.0000S.430.08	13271	8 L Ø 21	32 cm	S.S. 430 8	986.70
4513.0000S.430.12	13272	12 L Ø 25	32 cm	S.S. 430 6	1240.00
4513.0000S.430.16	13274	16 L Ø 25	38.5 cm	S.S. 430 6	1333.40
4513.0000S.430.20	13275	20 L Ø 25	46.5 cm	S.S. 430 6	1473.40
4513.0000S.430.27	13276	27 L Ø 25	57 cm	S.S. 430 6	1666.70
4513.0000S.430.32	13277	32 L Ø 31	46 cm	S.S. 430 4	2090.00
4513.0000S.430.45	13278	45 L Ø 31	57 cm	S.S. 430 4	2243.40

SİYAH

4513.0000S.102.05	32543	5 L Ø 21	26 cm	S.S. 430 8	910.00
4513.0000S.102.08	28656	8 L Ø 21	32 cm	S.S. 430 8	996.70
4513.0000S.102.12	32544	12 L Ø 25	32 cm	S.S. 430 6	1300.00
4513.0000S.102.16	32545	16 L Ø 25	38.5 cm	S.S. 430 6	1423.40
4513.0000S.102.20	32546	20 L Ø 25	46.5 cm	S.S. 430 6	1480.00
4513.0000S.102.27	28661	27 L Ø 25	57 cm	S.S. 430 6	1610.00
4513.0000S.102.32	32547	32 L Ø 31	46 cm	S.S. 430 4	2036.70
4513.0000S.102.45	28666	45 L Ø 31	57 cm	S.S. 430 4	2140.00

BEYAZ

4513.0000B.101.05	32528	5 L Ø 21	26 cm	S.S. 430 8	910.00
4513.0000B.101.08	28655	8 L Ø 21	32 cm	S.S. 430 8	996.70
4513.0000B.101.12	32529	12 L Ø 25	32 cm	S.S. 430 6	1300.00
4513.0000B.101.16	32530	16 L Ø 25	38.5 cm	S.S. 430 6	1423.40
4513.0000B.101.20	32531	20 L Ø 25	46.5 cm	S.S. 430 6	1480.00
4513.0000B.101.27	28660	27 L Ø 25	57 cm	S.S. 430 6	1610.00
4513.0000B.101.32	32532	32 L Ø 31	46 cm	S.S. 430 4	2036.70
4513.0000B.101.45	28665	45 L Ø 31	57 cm	S.S. 430 4	2140.00



• Paslanmaz gövde



PRATİK ÇEMBERLİ

Ürün Kodu	Kısa Kod	Çap	Yükseklik	Kalite	Fiyat
SS 430					
4514.0000S.430.05	13279	5 L Ø 21	26 cm	S.S. 430 8	743.40
4514.0000S.430.08	13280	8 L Ø 21	32 cm	S.S. 430 8	836.70
4514.0000S.430.12	13281	12 L Ø 25	32 cm	S.S. 430 6	1060.00
4514.0000S.430.16	13282	16 L Ø 25	38.5 cm	S.S. 430 6	1156.70
4514.0000S.430.20	13283	20 L Ø 25	46.5 cm	S.S. 430 6	1303.40
4514.0000S.430.27	13284	27 L Ø 25	57 cm	S.S. 430 6	1433.40
4514.0000S.430.32	13285	32 L Ø 31	46 cm	S.S. 430 4	1816.70
4514.0000S.430.45	13286	45 L Ø 31	57 cm	S.S. 430 4	2043.40

SİYAH

4514.0000S.102.05	32533	5 L Ø 21	26 cm	8	726.70
4514.0000S.102.08	28671	8 L Ø 21	32 cm	8	803.40
4514.0000S.102.12	32534	12 L Ø 25	32 cm	6	1060.00
4514.0000S.102.16	32535	16 L Ø 25	38.5 cm	6	1170.00
4514.0000S.102.20	32536	20 L Ø 25	46.5 cm	6	1230.00
4514.0000S.102.27	28676	27 L Ø 25	57 cm	6	1356.70
4514.0000S.102.32	32537	32 L Ø 31	46 cm	4	1703.40
4514.0000S.102.45	28681	45 L Ø 31	57 cm	4	1886.70

BEYAZ

4514.0000S.101.05	32538	5 L Ø 21	26 cm	8	726.70
4514.0000S.101.08	28670	8 L Ø 21	32 cm	8	803.40
4514.0000S.101.12	32539	12 L Ø 25	32 cm	6	1060.00
4514.0000S.101.16	32540	16 L Ø 25	38.5 cm	6	1170.00
4514.0000S.101.20	32541	20 L Ø 25	46.5 cm	6	1230.00
4514.0000S.101.27	28675	27 L Ø 25	57 cm	6	1356.70
4514.0000S.101.32	32542	32 L Ø 31	46 cm	4	1703.40
4514.0000S.101.45	28680	45 L Ø 31	57 cm	4	1886.70





- Paslanmaz gövde
- Kapaksız



- Paslanmaz gövde
- Paslanmaz kapak



- Paslanmaz gövde
- Paslanmaz kapak



- Paslanmaz gövde
- Paslanmaz kapak

KAPAKSIZ

Ürün Kodu	Kısa Kod	Çap	Yükseklik	Kalite	Fiyat
SS 430					
4503.1823S.430.03	13288	3 L Ø 21	19.5 cm	S.S. 430	8 386.70
4503.2026S.430.05	13289	5 L Ø 21	24 cm	S.S. 430	8 420.00
4503.2033S.430.08	13290	8 L Ø 21	33 cm	S.S. 430	6 600.00
4503.2433S.430.12	13291	12 L Ø 25	33 cm	S.S. 430	6 673.40
4503.2441S.430.16	13292	16 L Ø 25	42 cm	S.S. 430	4 893.40
SS 304					
4503.1823S.304.03	13293	3 L Ø 21	19.5 cm	S.S. 304	8 496.70
4503.2026S.304.05	13294	5 L Ø 21	24 cm	S.S. 304	8 546.70
4503.2035S.304.08	13295	8 L Ø 21	33 cm	S.S. 304	6 780.00
4503.2435S.304.12	13296	12 L Ø 25	33 cm	S.S. 304	6 883.40
OFİS TİPİ					
4506.2529S.000.00	13329	8 L Ø 21	23.5 cm	S.S. 430	8 500.00

ÇEMBERLİ

Ürün Kodu	Kısa Kod	Çap	Yükseklik	Kalite	Fiyat
SS 430					
4504.1924S.430.03	13298	3 L Ø 21	20.5 cm	S.S. 430	8 553.40
4504.2127S.430.05	13299	5 L Ø 21	24 cm	S.S. 430	8 586.70
4504.2034S.430.08	13300	8 L Ø 21	33 cm	S.S. 430	6 773.40
4504.2434S.430.12	13301	12 L Ø 25	33 cm	S.S. 430	6 880.00
4504.2442S.430.16	13302	16 L Ø 25	42 cm	S.S. 430	4 1103.40
SS 304					
4504.1924S.304.03	13303	3 L Ø 21	20.5 cm	S.S. 304	8 690.00
4504.2127S.304.05	13304	5 L Ø 21	24 cm	S.S. 304	8 740.00
4504.2034S.304.08	13305	8 L Ø 21	33 cm	S.S. 304	6 923.40
4504.2434S.304.12	13306	12 L Ø 25	33 cm	S.S. 304	6 1083.40
YANMAZ					
4507.2125S.430.08	13330	8 L Ø 21	25 cm	S.S. 430	8 646.70

ENDÜSTRİYEL ÇÖP KOVASI

Ürün Kodu	Kısa Kod	Ölçü	Fiyat
50 LT			
4515.4045S.430.50	19769	40x47 cm	1 4976.70
70 LT			
4515.4065S.430.70	19770	40x67 cm	1 5816.70

ÇEMBERLİ ENDÜSTRİYEL ÇÖP KOVASI

Ürün Kodu	Kısa Kod	Ölçü	Fiyat
50 LT			
4515.4045A.430.50	32548	40x47 cm	1 3366.70
70 LT			
4515.4045A.430.70	32549	40x67 cm	1 4160.00

*Boyalı ürünlerde 500 Adet ve üzeri siparişlerde özel renk seçenekleri mevcuttur.

LÜKS KARE PEDALLI ÇÖP KOVASI

Ürün Kodu	Kısa Kod	Ölçü	Fiyat
SS 430			
4511.3040S.430.00	29718	24x28x50 cm	3736.70
RENKLİ			
4511.3040B.101.00	29719	BEYAZ 24x28x50 cm	3240.00
4511.3040S.102.00	29720	SİYAH 24x28x50 cm	3240.00



DÜZ KAPAK

Ürün Kodu	Kısa Kod	Yükseklik	Kalite	Fiyat
SS 430				
4513.2860S.430.0	13326 Ø 27	59.5 cm	S.S. 430	1653.40
BEYAZ				
4513.2860S.101.B	28730 Ø 27	59.5 cm		1580.00
SİYAH				
4513.2860S.102.S	28731 Ø 27	59.5 cm		1580.00



BOMBE KAPAK

Ürün Kodu	Kısa Kod	Yükseklik	Kalite	Fiyat
SS 430				
4512.2867S.000.00	13327 Ø 27	62 cm	S.S. 430	1630.00
BEYAZ				
4512.2867S.101.B	28735 Ø 27	62 cm		1566.70
SİYAH				
4512.2867S.102.S	28736 Ø 27	62 cm		1566.70



AÇIK KAPAK

Ürün Kodu	Kısa Kod	Yükseklik	Fiyat
SS 430			
4510.2463S.430.36	28795	36 L 42 cm	2693.40
BEYAZ			
4510.2463B.101.36	28790	36 L 42 cm	2416.70
SİYAH			
4510.2463S.102.36	28791	36 L 42 cm	2416.70



SALLANIR KAPAK



Ürün Kodu	Kısa Kod	Yükseklik	Kalite	Fiyat
SS 304				
4508.1528S.304.07	13318	7 L	15x17x27 cm	S.S. 304 1 1306.70
4508.1839S.304.11	13319	11 L	18x20x38 cm	S.S. 304 1 2013.40
4508.1850S.304.16	13320	16 L	18x20x49 cm	S.S. 304 1 2423.40
4508.2448S.304.25	13321	25 L	24x28x50 cm	S.S. 304 1 3520.00
4508.2463S.304.36	13322	36 L	24x28x65 cm	S.S. 304 1 4376.70
4508.3055S.304.45	13323	45 L	30x35x55 cm	S.S. 304 1 5120.00
4508.3061S.304.54	13324	54 L	30x34x62 cm	S.S. 304 1 5173.40
4508.3089S.304.80	13325	80 L	30x35x90 cm	S.S. 304 1 6613.40

SS 430

4508.1528S.430.07	13309	7 L	15x17x27 cm	S.S. 430 1 1003.40
4508.1839S.430.11	13310	11 L	18x20x38 cm	S.S. 430 1 1483.40
4508.1850S.430.16	13311	16 L	18x20x49 cm	S.S. 430 1 1783.40
4508.2448S.430.25	13312	25 L	24x28x50 cm	S.S. 430 1 2546.70
4508.2463S.430.36	13313	36 L	24x28x65 cm	S.S. 430 1 3213.40
4508.3055S.430.45	13314	45 L	30x35x55 cm	S.S. 430 1 3756.70
4508.3061S.430.54	13315	54 L	30x34x62 cm	S.S. 430 1 4020.00
4508.3089S.430.80	13316	80 L	30x35x90 cm	S.S. 430 1 4713.40

BEYAZ

4508.1528B.101.07	28685	7 L	15x17x27 cm	1 850.00
4508.1839B.101.11	28690	11 L	18x20x38 cm	1 1233.40
4508.1850B.101.16	28695	16 L	18x20x49 cm	1 1546.70
4508.2448B.101.25	28700	25 L	24x28x50 cm	1 2083.40
4508.2463B.101.36	28705	36 L	24x28x65 cm	1 2803.40
4508.3055B.101.45	28710	45 L	30x35x55 cm	1 3193.40
4508.3061B.101.54	28715	54 L	30x34x62 cm	1 3390.00
4508.3089B.101.80	28720	80 L	30x35x90 cm	1 3876.70

RENKLİ SİYAH

4508.1528S.102.07	28686	7 L	15x17x27 cm	1 850.00
4508.1839S.102.11	28691	11 L	18x20x38 cm	1 1233.40
4508.1850S.102.16	28696	16 L	18x20x49 cm	1 1546.70
4508.2448S.102.25	28701	25 L	24x28x50 cm	1 2083.40
4508.2463S.102.36	28706	36 L	24x28x65 cm	1 2803.40
4508.3055S.102.45	28711	45 L	30x35x55 cm	1 3193.40
4508.3061S.102.54	28716	54 L	30x34x62 cm	1 3390.00
4508.3089S.102.80	28721	80 L	30x35x90 cm	1 3876.70

ZARF TİPİ



Ürün Kodu	Kısa Kod	Yükseklik	Kalite	Fiyat
SS 304				
4509.3090S.304.80	28726	80 L	30x35x90 cm	S.S. 304 1 6593.40
SS 430				
4509.3090S.430.80	28725	80 L	30x35x90 cm	S.S. 430 1 4703.40
RENKLİ BEYAZ				
4509.3090B.101.80	28727	80 L	30x35x90 cm	1 3753.40
RENKLİ SİYAH				
4509.3090S.102.80	28728	80 L	30x35x90 cm	1 3753.40

*Boyalı ürünlerde 500 Adet ve üzeri siparişlerde özel renk seçenekleri mevcuttur.

AKSESUAR SETLERİ

MAXIFLOW
Maksimum akış...

SET ÜSTÜ SIVI SABUNLUK

Ürün Kodu	Kısa Kod	Renk	Çap	Yükseklik	Fiyat	
PASLANMAZ SS 430						
4711.17.718.1	26460		Ø 7	17 cm	20	296.70
RENKLİ						
4711.18.71.B	26464	BEYAZ	Ø 7	17 cm	20	303.40
4711.18.71.S	26463	SİYAH	Ø 7	17 cm	20	303.40
4711.18.71.K	26461	KIRMIZI	Ø 7	17 cm	20	303.40



DİŞ FIRÇALIK

Ürün Kodu	Kısa Kod	Renk	Çap	Yükseklik	Fiyat	
PASLANMAZ SS 430						
4711.22.711.1	26455		Ø 7	12 cm	20	176.70
RENKLİ						
4711.22.711.B	26454	BEYAZ	Ø 7	12 cm	20	183.40
4711.22.711.S	26453	SİYAH	Ø 7	12 cm	20	183.40
4711.22.711.K	26451	KIRMIZI	Ø 7	12 cm	20	183.40



STANDART

Ürün Kodu	Kısa Kod	Renk	Fiyat
SS 430 2'Lİ SET			
ST.0102.430.P	26441		6 846.70
BOYALI 2'Lİ SET			
ST.0402.101.B	26446	BEYAZ	6 846.70
ST.0302.102.S	26445	SİYAH	6 846.70
ST.0102.104.K	26443	KIRMIZI	6 846.70



STANDART

Ürün Kodu	Kısa Kod	Renk	Fiyat
SS 430 4'LÜ SET			
ST.0104.430.P	26442		6 1193.40
BOYALI 4'LÜ SET			
ST.0404.101.B	26450	BEYAZ	6 1186.70
ST.0304.102.S	26449	SİYAH	6 1186.70
ST.0104.104.K	26447	KIRMIZI	6 1186.70





**YANMAZ
KOKUSUZ**

BORU TİPİ KÜLLÜK

Ürün Kodu	Kısa Kod	Çap	Yükseklik	Kalite	Fiyat
SS 304					
4418.1182S.304.00	18182	Ø 10.50	83 cm	S.S. 304	4 4483.40
BEYAZ					
4418.1182B.101.00	28780	Ø 10.50	83 cm		4 2363.40
SİYAH					
4418.1182S.102.00	28781	Ø 10.50	83 cm		4 2363.40

New



**YANMAZ
KOKUSUZ**

TERAS ASKILI KÜLLÜK

Ürün Kodu	Kısa Kod	Çap	Yükseklik	Kalite	Fiyat
4418.1120S.430.00	34878	Ø 10	20 cm	S.S. 430	20 470.00
4418.1128S.430.00	34879	Ø 10	28 cm	S.S. 430	20 543.40
BOYALI					
4418.1120S.102.00	34880	Ø 10	20 cm	SİYAH	20 393.40
4418.1128S.102.00	34881	Ø 10	28 cm	SİYAH	20 430.00



**YANMAZ
KOKUSUZ**

DEKORATİF KÜLLÜK

Ürün Kodu	Kısa Kod	Çap	Yükseklik	Kalite	Fiyat
4419.0709M.304.00	26457	Ø 7	10 cm	S.S. 304	50 343.40
4419.0709M.430.00	31410	Ø 7	10 cm	S.S. 430	50 276.70
BOYALI					
4419.0709M.101.00	28775	Ø 7	10 cm	BEYAZ	50 203.40
4419.0709M.102.00	28776	Ø 7	10 cm	SİYAH	50 203.40



KÜLLÜKLER

STANDART KOLON KÜLLÜK

MAXIFLOW
Maksimum akış...

Ürün Kodu	Kısa Kod	Çap	Yükseklik		Fiyat
SS 430					
4418.1960S.430.00	13333	Ø 19	60 cm	S.S. 430	8 1066.70
4418.2160S.430.00	13334	Ø 21	60 cm	S.S. 430	8 1136.70
4418.2560S.430.00	13335	Ø 25	60 cm	S.S. 430	6 1416.70
4418.2860S.430.00	13336	Ø 28	60 cm	S.S. 430	4 1686.70
RENKLİ NO1					
4418.1960B.101.00	28740	Ø 19	60 cm	BEYAZ	8 1053.40
4418.1960S.102.00	28741	Ø 19	60 cm	SİYAH	8 1053.40
RENKLİ NO2					
4418.2160B.101.00	28745	Ø 21	60 cm	BEYAZ	8 1116.70
4418.2160S.102.00	28746	Ø 21	60 cm	SİYAH	8 1116.70
RENKLİ NO3					
4418.2560B.101.00	28750	Ø 25	60 cm	BEYAZ	6 1400.00
4418.2560S.102.00	28751	Ø 25	60 cm	SİYAH	6 1400.00
RENKLİ NO4					
4418.2860B.101.00	28755	Ø 28	60 cm	BEYAZ	4 1666.70
4418.2860S.102.00	28756	Ø 28	60 cm	SİYAH	4 1666.70



LÜKS KOLON KÜLLÜK

Ürün Kodu	Kısa Kod	Çap	Yükseklik		Fiyat
SS 430					
4417.1960S.430.00	29702	Ø 19	60 cm	S.S. 430	8 1493.40
4417.2160S.430.00	29703	Ø 21	60 cm	S.S. 430	8 1600.00
4417.2560S.430.00	29704	Ø 25	60 cm	S.S. 430	6 2010.00
4417.2860S.430.00	29705	Ø 28	60 cm	S.S. 430	4 2370.00
RENKLİ NO1					
4417.1960B.101.00	29710	Ø 19	60 cm	BEYAZ	8 1473.40
4417.1960S.102.00	29706	Ø 19	60 cm	SİYAH	8 1473.40
RENKLİ NO2					
4417.2160B.101.00	29711	Ø 21	60 cm	BEYAZ	8 1573.40
4417.2160S.102.00	29707	Ø 21	60 cm	SİYAH	8 1573.40
RENKLİ NO3					
4417.2560B.101.00	29712	Ø 25	60 cm	BEYAZ	6 2000.00
4417.2560S.102.00	29708	Ø 25	60 cm	SİYAH	6 2000.00
RENKLİ NO4					
4417.2860B.101.00	29713	Ø 28	60 cm	BEYAZ	4 2346.70
4417.2860S.102.00	29709	Ø 28	60 cm	SİYAH	4 2346.70



LÜKS MİNİ İZGARALI KOLON KÜLLÜK

Ürün Kodu	Kısa Kod	Yükseklik	Kalite		Fiyat
SS 430					
4418.1458S.430.00	29734	Ø 14	58 cm	S.S. 430	8 1293.40
BEYAZ					
4418.1458B.101.00	29736	Ø 14	58 cm		8 1210.00
SİYAH					
4418.1458S.102.00	29735	Ø 14	58 cm		8 1210.00



IZGARALI KOLON KÜLLÜK



Ürün Kodu	Kısa Kod	Çap	Yükseklik	Kalite	Fiyat
SS 430					
4513.2860I.430.0	13331	Ø 26	60 cm	S.S. 430	6 1583.40



ŞAMPANYA KÜLLÜK

Ürün Kodu	Kısa Kod	Yükseklik	Kalite	Fiyat
SS 430				
4418.3165S.430.00	13340	Ø 32	61 cm	S.S. 430 4 1410.00
RENKLİ BEYAZ				
4418.3165B.101.00	28765	Ø 32	61 cm	4 1486.70
RENKLİ SİYAH				
4418.3165S.102.00	28766	Ø 32	61 cm	4 1486.70



LOBİ KÜLLÜK

Ürün Kodu	Kısa Kod	Yükseklik	Kalite	Fiyat
SS 430				
4418.2671S.430.00	13339	Ø 26	67 cm	S.S. 430 4 1463.40
RENKLİ BEYAZ				
4418.2671B.101.00	28760	Ø 26	67 cm	4 1473.40
RENKLİ SİYAH				
4418.2671S.102.00	28761	Ø 26	67 cm	4 1473.40

U TİPİ

Ürün Kodu	Kısa Kod	Ölçü	Fiyat
DKP			
4505.5047S.000.00	13345	45x72.5x42 cm	3840.00

• Boyalı



BORU TİPİ

Ürün Kodu	Kısa Kod	Ölçü	Fiyat
DKP			
4539.5049U.000.00	13346	45x117 cm	3143.40

• Boyalı



ŐAPKALI

Ürün Kodu	Kısa Kod	Ölçü	Fiyat
DKP			
4539.5048S.000.00	13347	45x117x45 cm	3996.70

• Boyalı



BORU TİPİ DÜZ

Ürün Kodu	Kısa Kod	Ölçü	Fiyat
DKP			
4505.5045S.000.00	13348	45x100 cm	3070.00

• Boyalı



KARE AYAKLI BAHÇE TİPİ ÇÖP KOVASI



Ürün Kodu	Kısa Kod	Ölçü	Fiyat
SS 430			
4418.30101S.430.00	29714	S.S. 430 30x26x102 cm	4586.70
RENKLİ			
4418.30101Y.106.00	29715	YEŞİL 30x26x102 cm	3750.00
4418.30101B.101.00	29716	BEYAZ 30x26x102 cm	3750.00
4418.30101S.102.00	29717	SIYAH 30x26x102 cm	3750.00



LÜKS IZGARALI DIŞ MEKAN ÇÖP KOVASI

Ürün Kodu	Kısa Kod	Ölçü	Fiyat
SS 430			
4505.5044S.430.00	29721	S.S. 430 45x72.5x42 cm	4383.40
DKP			
4505.5043S.000.00	29722	DKP 45x72.5x42 cm	4383.40



ŞAPKALI PASLANMAZ

Ürün Kodu	Kısa Kod	Ölçü	Fiyat
DKP + INOX			
4539.5048S.430.00	27287	45x117x45 cm	4236.70

- Boyalı
- Paslanmaz



PASLANMAZ BAHÇE

Ürün Kodu	Kısa Kod	Ölçü	Fiyat
PASLANMAZ U TİPİ SS 304			
4518.50745.000.00	13350	50x47x74 cm	8860.00
PASLANMAZ ŞAPKALI SS 304			
4518.5099S.000.00	13349	50x48x115 cm	9263.40

BASTON AYAK

Ürün Kodu	Kısa Kod	Ölçü	Fiyat
DKP			
4539.6049U.000.00	34385	45x117 cm	3116.70

New



ŐEMSIYELİ

Ürün Kodu	Kısa Kod	Ölçü	Fiyat
DKP			
4539.6048S.000.00	34386	45x117x45 cm	4073.40

New



DİRSEKLİ LAMALI

Ürün Kodu	Kısa Kod	Ölçü	Fiyat
DKP			
4423.3285H.106.00	34387	45x85x42 cm	4786.70

New



DİRSEKLİ BORULU

Ürün Kodu	Kısa Kod	Ölçü	Fiyat
DKP			
4423.3285U.106.00	34388	45x85x42 cm	4953.40

New



New



3 KOLLU YUVARLAK KÜLLÜK

Ürün Kodu	Kısa Kod	Kalite	Ölçü		Fiyat
4430.2888U.106.36	34389	DKP	28x88 cm	1	3003.40
4430.2888U.430.36	34390	SS430	28x88 cm	1	3156.70

New



DEKORATİF AÇIK ŞAPKALI

Ürün Kodu	Kısa Kod	Kalite	Ölçü		Fiyat
4426.4297U.106.70	34391	DKP	42x102 cm	1	6573.40
4426.4297U.430.70	34392	SS430	42x102 cm	1	7846.70

New



BORU KÜLLÜKLÜ

Ürün Kodu	Kısa Kod	Kalite	Ölçü		Fiyat
4529.2841U.106.36	34393	DKP	45x117x45 cm	4	2963.40
4529.2841U.430.36	34596	SS430	45x117x45 cm	4	3120.00

New

KÜLLÜK KAPAKLI

Ürün Kodu	Kısa Kod	Kalite	Ölçü		Fiyat
4428.3530H.106.50	34394	DKP	30x35x77 cm	1	4206.70
4428.3530H.430.50	34395	SS430	30x35x77 cm	1	5140.00



New

TAŐLI KÜLLÜKLÜ

Ürün Kodu	Kısa Kod	Kalite	Ölçü		Fiyat
4428.3530U.106.50	34396	DKP	30x35x77 cm	1	4430.00
4428.3530U.430.50	34397	SS430	30x35x77 cm	1	5420.00



New

YUVARLAK KOLONLU KÜLLÜK

Ürün Kodu	Kısa Kod	Ölçü		Fiyat
DKP				
4524.3236U.106.36	34398	32x36x75 cm	1	5036.70
4524.4045U.106.80	34399	40x45x102 cm	1	8936.70



New**KARE AYAKLI**

Ürün Kodu	Kısa Kod	Kalite	Ölçü	Fiyat
4425.2438H.106.36	34400	DKP	24x38x100 cm	4823.40
4425.2438H.430.36	34401	SS430	24x38x100 cm	7423.40

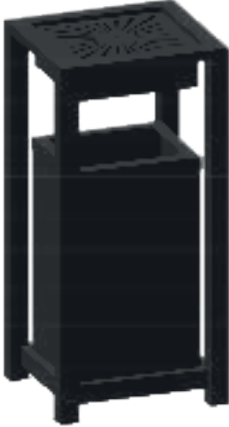
New**IZGARALI KAFES TİPİ**

Ürün Kodu	Kısa Kod	Ölçü	Fiyat
DKP			
4427.3337U.106.36	34402	33x37x77 cm	7260.00

New**TASLI KAFES TİPİ**

Ürün Kodu	Kısa Kod	Ölçü	Fiyat
DKP			
4427.3337T.106.36	34403	33x37x77 cm	6646.70

İKİLİ YÖNLENDİRMELİ

Ürün Kodu	Kısa Kod	Ölçü	Kalite	Fiyat
SS 430 2'Lİ				
AT.113.2430.P	34404	62x36x65 cm	S.S. 430	9516.70
BOYALI 2'Lİ				
AT.113.2102.B	34405	62x36x65 cm	DKP	7413.40

New



ÜÇLÜ YÖNLENDİRMELİ

Ürün Kodu	Kısa Kod	Ölçü	Kalite	Fiyat
SS 430 3'LÜ				
AT.113.3430.P	34406	92x36x65 cm	S.S. 430	12470.00
BOYALI 3'LÜ				
AT.113.3102.B	34407	92x36x65 cm	DKP	9483.40

New

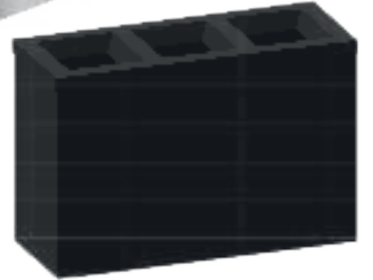

DÖRTLÜ YÖNLENDİRMELİ

Ürün Kodu	Kısa Kod	Ölçü	Kalite	Fiyat
SS 430 4'LÜ				
AT.113.4430.P	34408	123x36x65 cm	S.S. 430	15276.70
BOYALI 4'LÜ				
AT.113.4102.B	34409	123x36x65 cm	DKP	11370.00

New

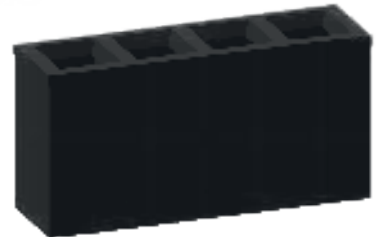

New**YUVARLAK AĞAÇ TIPI**

Ürün Kodu	Kısa Kod	Ölçü		Fiyat
DKP				
4421.3275U.102.00	34410	Ø22x65 cm	1	5296.70

New**KARE AĞAÇ TIPI**

Ürün Kodu	Kısa Kod	Ölçü		Fiyat
DKP				
4422.3275U.102.00	34411	30x46x65 cm	1	6173.40

New**İKİLİ OVAL AĞAÇ DÜZ KAPAK**

Ürün Kodu	Kısa Kod	Ölçü		Fiyat
DKP				
AT.112.2100.B	34412	38x73x61 cm	1	10706.70

New**ÜÇLÜ OVAL AĞAÇ DÜZ KAPAK**

Ürün Kodu	Kısa Kod	Ölçü		Fiyat
DKP				
AT.112.3100.B	34413	33x106x77 cm	1	12676.70

New**DÖRTLÜ OVAL AĞAÇ DÜZ KAPAK**

Ürün Kodu	Kısa Kod	Ölçü		Fiyat
DKP				
AT.112.4100.B	34414	33x138x77 cm	1	15833.40

İKİLİ ZARF KAPAK

Ürün Kodu	Kısa Kod	Ölçü	Kalite	Fiyat
SS 430 2'Lİ				
AT.101.2430.P	34415	74x35.5x92 cm	S.S. 430	10623.40
BOYALI 2'Lİ				
AT.101.2100.B	34416	74x35.5x92 cm	S.S. 430	9296.70



ÜÇLÜ ZARF KAPAK

Ürün Kodu	Kısa Kod	Ölçü	Kalite	Fiyat
SS 430 3'LÜ				
AT.101.3430.P	18251	111x35.5x92 cm	S.S. 430	14876.70
BOYALI 3'LÜ				
AT.101.3100.B	23433	111x35.5x92 cm	DKP	12793.40



DÖRTLÜ ZARF KAPAK

Ürün Kodu	Kısa Kod	Ölçü	Kalite	Fiyat
SS 430 4'LÜ				
AT.101.4430.P	23442	148x35.5x92 cm	S.S. 430	19806.70
BOYALI 4'LÜ				
AT.101.4100.B	23443	148x35.5x92 cm	DKP	17026.70



İKİLİ SALLANIR KAPAK

Ürün Kodu	Kısa Kod	Ölçü	Kalite	Fiyat
SS 430 2'Lİ				
AT.102.2430.P	34882	111x35.5x92 cm	S.S. 430	10966.70
BOYALI 2'Lİ				
AT.102.2130.P	34883	148x35.5x92 cm	S.S. 430	9533.40



ÜÇLÜ SALLANIR KAPAK

Ürün Kodu	Kısa Kod	Ölçü	Kalite	Fiyat
SS 430 3'LÜ				
AT.102.3430.P	18248	111x35.5x92 cm	S.S. 430	15390.00
BOYALI 3'LÜ				
AT.102.3100.B	18249	111x35.5x91 cm	DKP	13150.00



DÖRTLÜ SALLANIR KAPAK

Ürün Kodu	Kısa Kod	Ölçü	Kalite	Fiyat
SS 430 4'LÜ				
AT.102.4430.P	23439	148x35.5x92 cm	S.S. 430	20493.40
BOYALI 4'LÜ				
AT.102.4100.B	23440	148x35.5x91 cm	DKP	17500.00





İKİLİ BOMBE KAPAK

Ürün Kodu	Kısa Kod	Ölçü	Kalite		Fiyat
SS 430 2'Lİ					
AT.103.2430.P	34417	74x27x69.5 cm	S.S. 430	1	5243.40
BOYALI 2'Lİ					
AT.103.2100.B	34418	74x27x69.5 cm	DKP	1	5170.00



ÜÇLÜ BOMBE KAPAK

Ürün Kodu	Kısa Kod	Ölçü	Kalite		Fiyat
SS 430 3'LÜ					
AT.103.3430.P	13337	102x27x69.5 cm	S.S. 430	1	7930.00
BOYALI 3'LÜ					
AT.103.3100.B	13338	102x27x69.5 cm	DKP	1	7540.00



DÖRTLÜ BOMBE KAPAK

Ürün Kodu	Kısa Kod	Ölçü	Kalite		Fiyat
SS 430 4'LÜ					
AT.103.4430.P	23435	130x27x69.5 cm	S.S. 430	1	9760.00
BOYALI 4'LÜ					
AT.103.4100.B	23434	130x27x69.5 cm	DKP	1	9240.00



LÜKS KAPAK BOYALI

Ürün Kodu	Kısa Kod	Ölçü	Kalite		Fiyat
BOYALI 2'Lİ					
AT.110.2103.B	34419	62x36x73 cm	DKP	1	10603.40
BOYALI 3'LÜ					
AT.110.3103.B	32556	92x36x73 cm	DKP	1	12513.40
BOYALI 4'LÜ					
AT.110.4103.B	32557	122x36x73 cm	DKP	1	14466.70



İKİLİ OVAL KAPAK

Ürün Kodu	Kısa Kod	Ölçü	Kalite	Fiyat
SS 430 2'Lİ				
AT.106.2430.P	34884	92x36x81 cm	S.S. 430	10223.40
BOYALI 2'Lİ				
AT.106.2103.B	34885	92x36x81 cm	DKP	7966.70

ÜÇLÜ OVAL KAPAK

Ürün Kodu	Kısa Kod	Ölçü	Kalite	Fiyat
SS 430 3'LÜ				
AT.106.3430.P	32550	92x36x81 cm	S.S. 430	13293.40
BOYALI 3'LÜ				
AT.106.3103.B	32554	92x36x81 cm	DKP	9960.00

DÖRTLÜ OVAL KAPAK

Ürün Kodu	Kısa Kod	Ölçü	Kalite	Fiyat
SS 430 4'LÜ				
AT.106.4430.P	32551	123x36x81 cm	S.S. 430	16290.00
BOYALI 4'LÜ				
AT.106.4103.B	32555	123x36x81 cm	DKP	11863.40

İKİLİ KARE KAPAK

Ürün Kodu	Kısa Kod	Ölçü	Kalite	Fiyat
SS 430 2'Lİ				
AT.107.2430.P	34886	61x36x65 cm	S.S. 430	8730.00
BOYALI 2'Lİ				
AT.107.2103.B	34887	61x36x65 cm	DKP	6760.00

ÜÇLÜ KARE KAPAK

Ürün Kodu	Kısa Kod	Ölçü	Kalite	Fiyat
SS 430 3'LÜ				
AT.107.3430.P	32552	92x36x65 cm	S.S. 430	11476.70
BOYALI 3'LÜ				
AT.107.3103.B	33817	92x36x65 cm	DKP	8686.70

DÖRTLÜ KARE KAPAK

Ürün Kodu	Kısa Kod	Ölçü	Kalite	Fiyat
SS 430 4'LÜ				
AT.107.4430.P	32553	92x36x65 cm	S.S. 430	14043.40
BOYALI 4'LÜ				
AT.107.4103.B	32332	123x36x65 cm	DKP	10403.40

New



New



İKİLİ AÇILI SALLANIR KAPAK



New

Ürün Kodu	Kısa Kod	Ölçü	Kalite		Fiyat
SS 430 2'Lİ					
AT.114.2430.P	34420	38x76x83 cm	S.S. 430	1	16053.40
BOYALI 2'Lİ					
AT.114.2102.B	34421	38x76x83 cm	DKP	1	11760.00

ÜÇLÜ AÇILI SALLANIR KAPAK



New

Ürün Kodu	Kısa Kod	Ölçü	Kalite		Fiyat
SS 430 3'LÜ					
AT.114.3430.P	34422	38x112x83 cm	S.S. 430	1	20153.40
BOYALI 3'LÜ					
AT.114.3102.B	34423	38x112x83 cm	DKP	1	14406.70

DÖRTLÜ AÇILI SALLANIR KAPAK



New

Ürün Kodu	Kısa Kod	Ölçü	Kalite		Fiyat
SS 430 4'LÜ					
AT.114.4430.P	34424	38x148x83 cm	S.S. 430	1	24703.40
BOYALI 4'LÜ					
AT.114.4102.B	34425	38x148x83 cm	DKP	1	17490.00

İKİLİ AÇILI ÇEMBERLİ SALLANIR KAPAK



New

Ürün Kodu	Kısa Kod	Ölçü	Kalite		Fiyat
SS 430 2'Lİ					
AT.115.2430.P	34426	38x76x88 cm	S.S. 430	1	16703.40
BOYALI 2'Lİ					
AT.115.2102.B	34427	38x76x88 cm	DKP	1	12263.40

ÜÇLÜ AÇILI ÇEMBERLİ SALLANIR KAPAK



New

Ürün Kodu	Kısa Kod	Ölçü	Kalite		Fiyat
SS 430 3'LÜ					
AT.115.3430.P	34428	38x112x88 cm	S.S. 430	1	21126.70
BOYALI 3'LÜ					
AT.115.3102.B	34429	38x112x88 cm	DKP	1	15166.70

DÖRTLÜ ÇEMBERLİ AÇILI SALLANIR KAPAK



New

Ürün Kodu	Kısa Kod	Ölçü	Kalite		Fiyat
SS 430 4'LÜ					
AT.115.4430.P	34430	38x148x88 cm	S.S. 430	1	26000.00
BOYALI 4'LÜ					
AT.115.4102.B	34431	38x148x88 cm	DKP	1	18490.00

ÇEMBERLİ KAPAK

Ürün Kodu	Kısa Kod	Ölçü	Kalite		Fiyat
SS 430 2'Lİ					
AT.104.2430.P	34432	77x31x70 cm	S.S. 430	1	6140.00
SS 430 3'LÜ					
AT.104.3430.P	18253	114x31x70 cm	S.S. 430	1	8906.70
SS 430 4'LÜ					
AT.104.4430.P	23436	150x31x70 cm	S.S. 430	1	11063.40

- Paslanmaz gövde

PRATİK KAPAK

Ürün Kodu	Kısa Kod	Ölçü	Kalite		Fiyat
SS 430 2'Lİ					
AT.105.2430.P	34433	77x31x70 cm	S.S. 430	1	6640.00
SS 430 3'LÜ					
AT.105.3430.P	18242	114x31x70 cm	S.S. 430	1	9656.70
SS 430 4'LÜ					
AT.105.4430.P	23437	150x31x70 cm	S.S. 430	1	12063.40

- Paslanmaz gövde



Çöpler atık değil
geri kazanılmayı bekleyen hammaddelerdir.



WC FIRÇALIKLAR

WC FIRÇALIKLAR



WC FIRÇALIKLAR

DÜZ KAPAK

Ürün Kodu	Kısa Kod	Çap	Yükseklik	Kalite	Fiyat
KF01.430K.36	13382	Ø 8	H.37 cm	S.S. 430	230.00
KF06.304K.36	13383	Ø 8	H.37 cm	S.S. 304	303.40
KF07.304K.36	13385	Ø 9	H.37 cm	S.S. 304	343.40
KF08.430K.36	13386	Ø 9	H.37 cm	S.S. 430	273.40

ASKILI

KF15.430K.36	13400	Ø 8	H.37 cm	S.S. 430	296.70
KF16.304K.36	13399	Ø 8	H.37 cm	S.S. 304	360.00
KF17.304K.36	13401	Ø 9	H.37 cm	S.S. 304	396.70
KF18.430K.36	13402	Ø 9	H.37 cm	S.S. 430	326.70



• Paslanmaz gövde

AKILLI KAPAK EKO

Ürün Kodu	Kısa Kod	Çap	Ölçü	Kalite	Fiyat
KF64.430K.36	27281	Ø 8	H.37 cm	S.S. 430	270.00
KF66.304K.36	32558	Ø 8	H.37 cm	S.S. 304	323.40
KF67.304K.36	32590	Ø 9	H.37 cm	S.S. 304	346.70
KF65.430K.36	27285	Ø 9	H.37 cm	S.S. 430	286.70

ASKILI

KF20.430K.36	33125	Ø 8	H.37 cm	S.S. 430	326.70
KF21.304K.36	32559	Ø 8	H.37 cm	S.S. 304	380.00
KF22.304K.36	32591	Ø 9	H.37 cm	S.S. 304	403.40
KF23.430K.36	27285	Ø 9	H.37 cm	S.S. 430	343.40



• Paslanmaz gövde

BOMBE KAPAK

Ürün Kodu	Kısa Kod	Çap	Yükseklik	Kalite	Fiyat
KF25.430K.36	13388	Ø 8	H.38 cm	S.S. 430	266.70
KF26.304K.36	13387	Ø 8	H.38 cm	S.S. 304	333.40
KF27.304K.36	13389	Ø 9	H.38 cm	S.S. 304	373.40
KF28.430K.36	13390	Ø 9	H.38 cm	S.S. 430	296.70

ASKILI

KF35.430K.36	13405	Ø 8	H.38 cm	S.S. 430	320.00
KF36.304K.36	13404	Ø 8	H.38 cm	S.S. 304	390.00
KF37.304K.36	13406	Ø 9	H.38 cm	S.S. 304	426.70
KF38.430K.36	13407	Ø 9	H.38 cm	S.S. 430	350.00



• Paslanmaz gövde

DÜZ KAPAK DELİKLİ

Ürün Kodu	Kısa Kod	Çap	Yükseklik	Kalite	Fiyat
KF46.430K.36	13392	Ø 9	H.37 cm	S.S. 430	283.40
KF45.304K.36	13391	Ø 9	H.37 cm	S.S. 304	353.40

ASKILI

KF48.430K.36	13409	Ø 9	H.37 cm	S.S. 430	340.00
KF47.304K.36	13408	Ø 9	H.37 cm	S.S. 304	410.00



Ürünlerimiz



göre üretilmiştir.



DELUXE

Ürün Kodu	Kısa Kod	Çap	Ölçü	Kalite		Fiyat
KF69.304K.36	28807	Ø 8	H.39 cm	S.S. 304	20	713.40



PİRAMİT LÜKS

Ürün Kodu	Kısa Kod	Çap	Yükseklik	Kalite		Fiyat
KF55.304K.36	13393	Ø 8	H.39 cm	S.S. 304	20	370.00
ASKILI						
KF56.304K.36	13410	Ø 8	H.39 cm	S.S. 304	20	426.70



BİYELİ

Ürün Kodu	Kısa Kod	Çap	Ölçü	Kalite		Fiyat
KF61.304K.36	13395	Ø 9	H.39.5 cm	S.S. 304	20	540.00



AKILLI KAPAK SİLİKON FIRÇA

Ürün Kodu	Kısa Kod	Çap	Ölçü	Kalite		Fiyat
LUX						
KF62.304K.36	13396	Ø 8	H.39 cm	S.S. 304	12	726.70
KARE						
KF63.304K.36	13397		37x8x8 cm	S.S. 304	12	1003.40



AYAKLI WC FIRÇALIK SET

Ürün Kodu	Kısa Kod	Ölçü	Kalite		Fiyat
KF68.304K.72	13398	H.80 cm	S.S. 430	8	1463.40
RENKLİ					
KF68.101B.72	28802	H.80 cm	BEYAZ	8	1470.00
KF68.102S.72	28803	H.80 cm	SİYAH	8	1470.00

WC FIRÇALIKLAR

MAXIFLOW
Maksimum akış...

AKILLI KAPAK SİLİKONLU BOYALI FIRÇA

Ürün Kodu	Kısa Kod	Renk	Ölçü	Fiyat
KF63.101B.36	28797	Beyaz	H.37 cm	12 870.00
KF63.102S.36	28798	Siyah	H.37 cm	12 870.00



BOYALI WC FIRÇALIK

Ürün Kodu	Kısa Kod	Çap	Renk	Ölçü	Fiyat
KF90.101B.36	18236	Ø 8	Beyaz	H.37 cm	20 250.00
KF91.102S.36	18238	Ø 8	Siyah	H.37 cm	20 250.00
KF80.101B.36	34434	Ø 9	Beyaz	H.37 cm	20 276.70
KF80.102S.36	34435	Ø 9	Siyah	H.37 cm	20 276.70



ASKILI

KF10.101B.36	32560	Ø 8	Beyaz	H.37 cm	20 303.40
KF10.102S.36	32561	Ø 8	Siyah	H.37 cm	20 303.40
KF11.101B.36	34437	Ø 9	Beyaz	H.37 cm	20 330.00
KF11.102S.36	34438	Ø 9	Siyah	H.37 cm	20 330.00

HİJYENİK FIRÇA

Ürün Kodu	Kısa Kod	Çap	Yükseklik	Kalite	Fiyat
EKO SAPLI					
KF96.102.36	26459	Siyah Ø 8.5	36x8x8 cm	S.S. 304	20 386.70
LÜKS SAPLI					
KF94.102.36	27377	Siyah Ø 9	36x8x8 cm	S.S. 304	20 473.40



New



15x15x210 cm

12x12x210 cm

mono
FONKSİYON

PASİFİK DUŞ KOLONU

Ürün Kodu	Kısa Kod	Ölçü	Fiyat
4957.01212.DK.1	32565	12x12x210 cm	18576.70
4957.01515.DK.1	32566	15x15x210 cm	21450.00

New



15x15x210 cm

12x12x210 cm

mono
FONKSİYON

ATLAS DUŞ KOLONU

Ürün Kodu	Kısa Kod	Ölçü	Fiyat
4957.01212.DK.2	32567	12x12x210 cm	19560.00
4957.01515.DK.2	32568	15x15x210 cm	22433.40

New



mono
FONKSİYON

16x10x210 cm

PASİFİK DUŞ KOLONU

Ürün Kodu	Kısa Kod	Ölçü	Fiyat
4957.01610.DK.1	34888	16x10x210 cm 1	21813.40

New



mono
FONKSİYON

16x10x210 cm

PASİFİK DUŞ KOLONU

Ürün Kodu	Kısa Kod	Ölçü	Fiyat
4957.01610.DK.2	34607	16x10x210 cm 1	22763.00





Parlak

DİŞ FIRÇALIK

Ürün Kodu	Kısa Kod	Ölçü	Fiyat
SS 304			
4711.22.711.0	13530	Ø 7x11 cm	20 323.40



Duvara
Montaj

Plastik
Pompa

Mat

Parlak

KÖPÜKLÜ

Ürün Kodu	Kısa Kod	Ölçü	Fiyat
SS 304			
4711.09.100.M	13411 Mat	1000 ml 22x6x13 cm	20 913.40
4711.09.100.P	13412 Parlak	1000 ml 22x6x13 cm	20 1006.70



SET ÜSTÜ / ASKILIKLI

Ürün Kodu	Kısa Kod	Ölçü	Fiyat
SS 304			
4711.17.718.0	13413	Ø 7x17 cm	20 390.00
4711.16.717.0	13414 Askılı	Ø 7x17 cm	20 443.40



KÜRE SET ÜSTÜ

Ürün Kodu	Kısa Kod	Ölçü	Fiyat
SS 304			
4711.19.916.0	13416	Ø 9x14.5 cm	20 416.70



ANKASTRE

Ürün Kodu	Kısa Kod	Çap	Ölçü	Fiyat
SIVI SABUNLUK				
4716.0921S.304.00	13426	Ø 9	21 cm	20 613.40
KÖPÜKLÜ				
4716.0921S.304.01	13427	Ø 9	21 cm	20 1703.40

ANKASTRE PİRİNÇ

Ürün Kodu	Kısa Kod	Çap	Ölçü	Fiyat
4716.0921S.304.02	32169	Ø 9	21 cm	20 1130.00



SABUNLUK

Ürün Kodu	Kısa Kod	Ölçü	Fiyat
SS 304 500 ml 4711.02.050.P	13417	16x6x10 cm	20 716.70
SS 304 1000 ml 4711.06.100.P	13419	22x6x13 cm	20 856.70



SABUNLUK

Ürün Kodu	Kısa Kod	Ölçü	Fiyat
SS 304 500 ml 4711.01.050.M	13420	16x6x10 cm	20 650.00
SS 304 1000 ml 4711.05.100.M	13421	22x6x13 cm	20 790.00



SABUNLUK

Ürün Kodu	Kısa Kod	Ölçü	Fiyat
SS 304 500 ml 4711.04.050.P	13422	16x6x10 cm	20 773.40
SS 304 1000 ml 4711.08.100.P	13423	22x6x13 cm	20 920.00



SABUNLUK

Ürün Kodu	Kısa Kod	Ölçü	Fiyat
SS 304 500 ml 4711.03.050.M	13424	16x6x10 cm	20 706.70
SS 304 1000 ml 4711.07.100.M	13425	22x6x13 cm	20 853.40

ÇÖP KOVALI KAĞITLIK

Ürün Kodu	Kısa Kod	Ölçü	Kalite		Fiyat
OVAL 200 'LÜK					
4546.2010S.102.00	29847	105x27.5x12 cm	Siyah	1	2856.70
4546.2010B.101.00	29846	105x27.5x12 cm	Beyaz	1	2856.70
4546.2010S.430.00	29845	105x27.5x12 cm	SS 430	1	3380.00
OVAL 400 'LÜK					
4546.2610S.102.00	29851	105x27.5x12 cm	Siyah	1	2996.70
4546.2610B.101.00	29850	105x27.5x12 cm	Beyaz	1	2996.70
4546.2610S.430.00	13352	105x27.5x12 cm	SS 430	1	3593.40
DÜZ 200 'LÜK					
4549.2010S.102.00	29844	105x27.5x12 cm	Siyah	1	2876.70
4549.2010B.101.00	29843	105x27.5x12 cm	Beyaz	1	2876.70
4549.2010S.430.00	29842	105x27.5x12 cm	SS 430	1	3406.70
DÜZ 400 'LÜK					
4549.2610S.102.00	29849	105x27.5x12 cm	Siyah	1	3006.70
4549.2610B.101.00	29848	105x27.5x12 cm	Beyaz	1	3006.70
4549.2610S.430.00	13354	105x27.5x12 cm	SS 430	1	3623.40



MASAÜSTÜ KAĞITLIK

Ürün Kodu	Kısa Kod	Ölçü	Kalite		Fiyat
MINİ					
4924.1014S.430.00	32573	13,5x9x3 cm	SS 430	24	390.00
4924.1014S.304.00	32574	13,5x9x3 cm	SS 304	24	510.00
MAXİ					
4924.1325S.430.00	32575	25x13x6 cm	SS 430	12	776.70
4924.1325S.304.00	32576	25x13x6 cm	SS 304	12	1033.40



KAPAKLI KAĞITLIK

Ürün Kodu	Kısa Kod	Ölçü	Kalite		Fiyat
AK.02.101A.B	32577	13x10x10 cm	Siyah	20	496.70
AK.02.102A.B	32578	13x10x10 cm	Beyaz	20	496.70
AK.02.430A.P	32579	13x10x10 cm	SS 430	20	633.40
AK.02.304A.P	32580	13x10x10 cm	SS 304	20	746.70



JUMBO WC KAĞIT VERİCİ



Ürün Kodu	Kısa Kod	Ölçü	Kalite		Fiyat
Ø 22					
4923.2212S.102.00	28900	12 cm	Siyah	20	716.70
4923.2212B.101.00	28899	12 cm	Beyaz	20	716.70
4923.2212S.430.00	13370	12 cm	SS 430	20	850.00
4923.2212S.304.00	13369	12 cm	SS 304	20	1123.40
Ø 27					
4923.2712S.102.00	28902	12 cm	Siyah	20	780.00
4923.2712B.101.00	28901	12 cm	Beyaz	20	780.00
4923.2712S.430.00	13372	12 cm	SS 430	20	916.70
4923.2712S.304.00	13371	12 cm	SS 304	20	1223.40

GÜLEN AĞIZ KAĞIT VERİCİ



Ürün Kodu	Kısa Kod	Ölçü	Kalite		Fiyat
4923.2739S.102.00	28906	28x5.5x39 cm	Siyah	12	523.40
4923.2739B.101.00	28905	28x5.5x39 cm	Beyaz	12	523.40
4923.2739S.430.00	13374	28x5.5x39 cm	SS 430	12	646.70
4923.2739S.304.00	13373	28x5.5x39 cm	SS 304	12	893.40

CİMRİ KAĞIT VERİCİ



Ürün Kodu	Kısa Kod	Ölçü	Kalite		Fiyat
4923.2013S.102.00	28904	Ø 21x13.5 cm	Siyah	12	1060.00
4923.2013B.101.00	28903	Ø 21x13.5 cm	Beyaz	12	1060.00
4923.2013S.304.00	13368	Ø 21x13.5 cm	SS 304	12	1553.40

Z KATLAMA KAĞIT HAVLULUK



Ürün Kodu	Kısa Kod	Ölçü	Kalite		Fiyat
200 'LÜK					
4922.2026S.102.00	28896	20.5x27x10 cm	Siyah	20	813.40
4922.2026B.101.00	28895	20.5x27x10 cm	Beyaz	20	813.40
4922.2026P.430.00	13365	20.5x27x10 cm	SS 430	20	943.40
4922.2026P.304.00	13364	20.5x27x10 cm	SS 304	20	1223.40
400 'LÜK					
4922.3226S.102.00	28898	27x35x10 cm	Siyah	20	956.70
4922.3226B.101.00	28897	27x35x10 cm	Beyaz	20	956.70
4922.3226P.430.00	13367	27x35x10 cm	SS 430	20	1170.00
4922.3226P.304.00	13366	27x35x10 cm	SS 304	20	1566.70



LAMALI RAF HAVLULUK

Ürün Kodu	Kısa Kod	Çap	Ölçü	Fiyat	
SS 304 4949.3051S.304.00	13526	Ø 19	50x29x12.5 cm	12	1306.70



RAF HAVLULUK

Ürün Kodu	Kısa Kod	Çap	Ölçü	Fiyat	
SS 304 4949.3162S.304.00	13527	Ø 19	50x20x13 cm	25	936.70



AÇILI DESTEKLİ RAF HAVLULUK

Ürün Kodu	Kısa Kod	Çap	Ölçü	Fiyat	
SS 304 4950.5019S.304.00	13528	Ø 19	50x28x19 cm	12	1233.40



DESTEKLİ RAF HAVLULUK

Ürün Kodu	Kısa Kod	Çap	Ölçü	Fiyat	
SS 304 4950.3162S.304.00	13529	Ø 19	50x29x12 cm	12	1136.70



ÇİFT KAT RAF HAVLULUK

Ürün Kodu	Kısa Kod	Ölçü	Fiyat	
SS 304 4947.3051S.304.00	28893	50x27x13 cm	12	1423.40



PASLANMAZ ETAJER

Ürün Kodu	Kısa Kod	Ölçü	Fiyat	
SS 304 AK.161.4709.P	27288	47x9x4 cm	5	540.00
SS 304 KORUMALI AK.162.4710.P	27289	47x9x4 cm	5	776.70

BANYO AKSESUARLARI

New



ETAJER

Ürün Kodu	Kısa Kod		Fiyat
AK.25.1011.P	34440	10	1413.40

New



DİŞ FIRÇALIK

Ürün Kodu	Kısa Kod		Fiyat
AK.25.3011.P	34441	10	1046.70

New



UZUN HAVLULUK 50 CM

Ürün Kodu	Kısa Kod		Fiyat
AK.25.5011.P	34442	20	1300.00

New



WC KAĞITLIK

Ürün Kodu	Kısa Kod		Fiyat
AK.25.7011.P	34443	20	756.70
AK.25.7511.P Kapaklı	34444	20	1136.70

New



SABUNLUK

Ürün Kodu	Kısa Kod		Fiyat
AK.25.2011.P	34445	10	1046.70

New



BORNOZ ASKILIĞI

Ürün Kodu	Kısa Kod		Fiyat
AK.25.4011.P	34446	20	710.00

New



YUVARLAK HAVLULUK

Ürün Kodu	Kısa Kod		Fiyat
AK.25.6011.P	34448	10	846.70

New



KAĞIT HAVLULUK

Ürün Kodu	Kısa Kod		Fiyat
AK.25.8011.P	34449	10	856.70

- Krom kaplama
- Zamak gövde



ETAJER

Ürün Kodu	Kısa Kod		Fiyat
AK.25.1011.G	34450	10	1636.70



DİŞ FIRÇALIK

Ürün Kodu	Kısa Kod		Fiyat
AK.25.3011.G	34451	10	1183.40



UZUN HAVLULUK 50 CM

Ürün Kodu	Kısa Kod		Fiyat
AK.25.5011.G	34452	20	1516.70

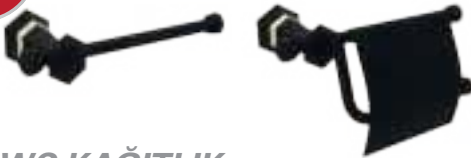

WC KAĞITLIK

Ürün Kodu	Kısa Kod		Fiyat
AK.25.7011.G	34453	20	873.40
AK.25.7511.G Kapaklı	34454	20	1283.40



SABUNLUK

Ürün Kodu	Kısa Kod		Fiyat
AK.25.2011.G	34455	10	1183.40



BORNOZ ASKILIĞI

Ürün Kodu	Kısa Kod		Fiyat
AK.25.4011.G	34456	20	823.40



YUVARLAK HAVLULUK

Ürün Kodu	Kısa Kod		Fiyat
AK.25.6011.G	34458	10	970.00



KAĞIT HAVLULUK

Ürün Kodu	Kısa Kod		Fiyat
AK.25.8011.G	34459	10	980.00

- Krom kaplama
- Zamak gövde



ETAJER

Ürün Kodu	Kısa Kod		Fiyat
AK.01.3901.P	13437	10	1110.00



DİŞ FIRÇALIK

Ürün Kodu	Kısa Kod		Fiyat
AK.01.3904.P	13439	10	916.70



UZUN HAVLULUK

Ürün Kodu	Kısa Kod		Fiyat
AK.06.3914.P	13442	20	1190.00



WC KAĞITLIK

Ürün Kodu	Kısa Kod		Fiyat
AK.04.3907.P	13444	20	720.00



SABUNLUK

Ürün Kodu	Kısa Kod		Fiyat
AK.01.3903.P	13438	10	916.70



BORNOZ ASKILIĞI

Ürün Kodu	Kısa Kod		Fiyat
AK.08.3927.P	13443	20	536.70



YUVARLAK HAVLULUK

Ürün Kodu	Kısa Kod		Fiyat
AK.01.3917.P	13440	10	843.40



WC KAPAKLI KAĞITLIK

Ürün Kodu	Kısa Kod		Fiyat
AK.05.3908.P	13445	20	903.40

- Krom kaplama
- Zamak gövde

- SS 304 kalite paslanmaz kapak ve boru
- Kutu ambalaj



ETAJER

Ürün Kodu	Kısa Kod	Adet	Fiyat
AK.11.3901.G	13446	10	1280.00



DİŞ FIRÇALIK

Ürün Kodu	Kısa Kod	Adet	Fiyat
AK.13.3904.G	13448	10	1113.40



UZUN HAVLULUK

Ürün Kodu	Kısa Kod	Adet	Fiyat
AK.16.3914.G	13450	20	1476.70



WC KAĞITLIK

Ürün Kodu	Kısa Kod	Adet	Fiyat
AK.14.3907.G	13452	20	933.40

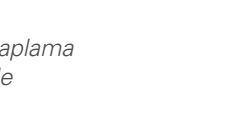

SABUNLUK

Ürün Kodu	Kısa Kod	Adet	Fiyat
AK.12.3903.G	13447	10	1113.40



BORNOZ ASKILIĞI

Ürün Kodu	Kısa Kod	Adet	Fiyat
AK.18.3927.G	13451	20	656.70



YUVARLAK HAVLULUK

Ürün Kodu	Kısa Kod	Adet	Fiyat
AK.17.3917.G	13449	10	1036.70



WC KAPAKLI KAĞITLIK

Ürün Kodu	Kısa Kod	Adet	Fiyat
AK.15.3908.G	13453	20	1243.40

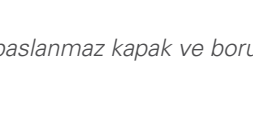

- Krom gold kaplama
- Zamak gövde

- SS 304 kalite paslanmaz kapak ve boru
- Kutu ambalaj



ETAJER

Ürün Kodu	Kısa Kod	Adet	Fiyat
AK.222.3901.B	30874	10	1110.00



DİŞ FIRÇALIK

Ürün Kodu	Kısa Kod	Adet	Fiyat
AK.221.3904.B	30873	10	916.70



UZUN HAVLULUK

Ürün Kodu	Kısa Kod	Adet	Fiyat
AK.224.3914.B	30876	20	1190.00



WC KAĞITLIK

Ürün Kodu	Kısa Kod	Adet	Fiyat
AK.225.3907.B	30877	20	720.00

- Siyah mat kaplama
- Zamak gövde



SABUNLUK

Ürün Kodu	Kısa Kod	Adet	Fiyat
AK.223.3903.B	30875	10	916.70



BORNOZ ASKILIĞI

Ürün Kodu	Kısa Kod	Adet	Fiyat
AK.220.3927.B	30872	20	536.70



YUVARLAK HAVLULUK

Ürün Kodu	Kısa Kod	Adet	Fiyat
AK.227.3917.B	30879	10	843.40



WC KAPAKLI KAĞITLIK

Ürün Kodu	Kısa Kod	Adet	Fiyat
AK.226.3908.B	30878	20	903.40

- SS 304 kalite paslanmaz kapak ve boru
- Kutu ambalaj



ETAJER

Ürün Kodu	Kısa Kod	Adet	Fiyat
AK.31.3601.P	13474	20	486.70



DİŞ FIRÇALIK

Ürün Kodu	Kısa Kod	Adet	Fiyat
AK.33.3604.P	13479	30	430.00



UZUN HAVLULUK

Ürün Kodu	Kısa Kod	Uzunluk	Adet	Fiyat
AK.40.3614.P	13475	40 cm	30	493.40



WC KAĞITLIK

Ürün Kodu	Kısa Kod	Adet	Fiyat
AK.34.3607.P	13480	40	303.40
AK.35.3608.P	13482	Kapaklı 40	390.00

- Krom kaplama
- Zamak gövde



SABUNLUK

Ürün Kodu	Kısa Kod	Adet	Fiyat
AK.32.3603.P	13477	30	430.00



BORNOZ ASKILIĞI

Ürün Kodu	Kısa Kod	Adet	Fiyat
AK.44.3621.P	13486	60	243.40
AK.45.3611.P	34447	60	230.00



YUVARLAK HAVLULUK

Ürün Kodu	Kısa Kod	Adet	Fiyat
AK.42.3617.P	13481	30	423.40



KAĞIT HAVLULUK

Ürün Kodu	Kısa Kod	Adet	Fiyat
AK.38.3612.P	13483	30	336.70
AK.39.3613.P	13485	Kapaklı 30	440.00

- SS 304 kalite paslanmaz kapak . Rozet ve çubuk
- Kutulu



New

ETAJER

Ürün Kodu	Kısa Kod		Fiyat
AK.10.1001.P	Poşetli	34461 75	850.00
AK.10.1011.P	Kutu	34462 12	996.70



New

SABUNLUK

Ürün Kodu	Kısa Kod		Fiyat
AK.10.2001.P	Poşetli	34469 100	610.00
AK.10.2011.P	Kutu	34470 12	683.40



New

DİŞ FIRÇALIK

Ürün Kodu	Kısa Kod		Fiyat
AK.10.3001.P	Poşetli	34463 100	610.00
AK.10.3011.P	Kutu	34464 12	683.40



New

BORNOZ ASKILIĞI

Ürün Kodu	Kısa Kod		Fiyat
AK.10.4001.P	Poşetli	34471 250	410.00
AK.10.4011.P	Kutu	34472 25	496.70



New

UZUN HAVLULUK 40 CM

Ürün Kodu	Kısa Kod		Fiyat
AK.10.5001.P	Poşetli	34465 130	826.70
AK.10.5011.P	Kutu	34466 12	996.70



New

YUVARLAK HAVLULUK

Ürün Kodu	Kısa Kod		Fiyat
AK.10.6001.P	Poşetli	34473 100	590.00
AK.10.6011.P	Kutu	34474 12	760.00



New

WC KAĞITLIK

Ürün Kodu	Kısa Kod		Fiyat
AK.10.7001.P	Poşetli	34467 100	463.40
AK.10.7011.P	Kutu	34468 12	613.40



New

KAPAKLI WC KAĞITLIK

Ürün Kodu	Kısa Kod		Fiyat
AK.10.7501.P	Poşetli	34475 80	650.00
AK.10.7511.P	Kutu	34476 12	793.40

- Krom kaplama
- Piriç gövde

- SS 304 kalite paslanmaz kapak ve boru
- Kutu ambalaj



KAĞIT HAVLULUK

Ürün Kodu	Kısa Kod		Fiyat
AK.10.8001.P	Poşetli	34477 80	500.00
AK.10.8011.P	Kutu	34478 25	626.70



BORNOZ ASKILIĞI

Ürün Kodu	Kısa Kod		Fiyat
AK.10.4501.P	Poşetli	34479 250	366.70
AK.10.4511.P	Kutu	34480 25	450.00



2'Lİ MAKAS HAVLULUK

Ürün Kodu	Kısa Kod		Fiyat
AK.10.5211.P		34481 12	2283.40



4'LÜ MAKAS HAVLULUK

Ürün Kodu	Kısa Kod		Fiyat
AK.10.5411.P		34482 12	3226.70

- Krom kaplama
- Piriç gövde

ZÜMRÜT SERİSİ



KAPAKLI KAĞIT HAVLULUK

Ürün Kodu	Kısa Kod		Fiyat
AK.10.8501.P	Poşetli	34483 70	663.40
AK.10.8511.P	Kutu	34484 25	790.00



BEKLETMELİ WC KAĞITLIK

Ürün Kodu	Kısa Kod		Fiyat
AK.10.7611.P		34485 12	1216.70



3'LÜ MAKAS HAVLULUK

Ürün Kodu	Kısa Kod		Fiyat
AK.10.5311.P		34486 12	2766.70

- SS 304 kalite paslanmaz kapak ve boru
- Kutu ambalaj



ETAJER

Ürün Kodu	Kısa Kod		Fiyat
AK.10.1011.G	34487	12	1243.40



DİŞ FIRÇALIK

Ürün Kodu	Kısa Kod		Fiyat
AK.10.3011.G	34488	12	920.00



UZUN HAVLULUK 40 CM

Ürün Kodu	Kısa Kod		Fiyat
AK.10.5011.G	34489	12	1213.40



WC KAĞITLIK

Ürün Kodu	Kısa Kod		Fiyat
AK.10.7011.G	34490	12	730.00
AK.10.7511.G	34491	12	930.00

- Krom gold kaplama
- Pirinç gövde



SABUNLUK

Ürün Kodu	Kısa Kod		Fiyat
AK.10.2011.G	34492	12	920.00

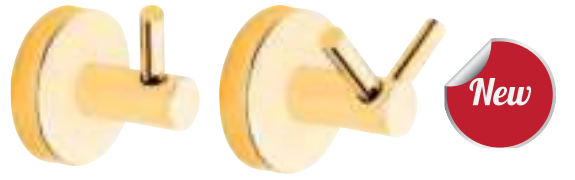

BORNOZ ASKILIĞI

Ürün Kodu	Kısa Kod		Fiyat
AK.10.4011.G	34493	25	596.70
AK.10.4511.G	34494	25	666.70



YUVARLAK HAVLULUK

Ürün Kodu	Kısa Kod		Fiyat
AK.10.6011.G	34495	12	920.00



KAPAKLI WC KAĞITLIK

Ürün Kodu	Kısa Kod		Fiyat
AK.10.8011.G	34496	25	793.40
AK.10.8511.G	34497	25	983.40

- SS 304 kalite paslanmaz kapak ve boru
- Kutu ambalaj



ETAJER

Ürün Kodu	Kısa Kod		Fiyat
AK.10.1011.B	34498	12	996.70



DİŞ FIRÇALIK

Ürün Kodu	Kısa Kod		Fiyat
AK.10.3011.B	34499	12	683.40



UZUN HAVLULUK 40 CM

Ürün Kodu	Kısa Kod		Fiyat
AK.10.5011.B	34500	12	996.70



WC KAĞITLIK

Ürün Kodu	Kısa Kod		Fiyat
AK.10.7011.B	34501	12	613.40
AK.10.7511.B	34502	12	793.40

- Mat siyah kaplama
- Piriç gövde



SABUNLUK

Ürün Kodu	Kısa Kod		Fiyat
AK.10.2011.B	34503	12	683.40



BORNOZ ASKILIĞI

Ürün Kodu	Kısa Kod		Fiyat
AK.10.4011.B	34504	25	450.00
AK.10.4511.B	34505	25	496.70



YUVARLAK HAVLULUK

Ürün Kodu	Kısa Kod		Fiyat
AK.10.6011.B	34506	12	760.00



KAPAKLI WC KAĞITLIK

Ürün Kodu	Kısa Kod		Fiyat
AK.10.8011.B	34507	25	626.70
AK.10.8511.B	34508	25	790.00

- SS 304 kalite paslanmaz kapak ve boru
- Kutu ambalaj



ETAJER

Ürün Kodu	Kısa Kod		Fiyat
AK.61.3511.P	Poşetli	34509 75	303.40
AK.61.3501.P	Kutu	26124 20	360.00
AK.61.3521.P	Blişter	34511 15	453.40



DİŞ FIRÇALIK

Ürün Kodu	Kısa Kod		Fiyat
AK.62.3514.P	Poşetli	34512 100	156.70
AK.62.3504.P	Kutu	26125 30	193.40
AK.62.3524.P	Blişter	34514 30	223.40



UZUN HAVLULUK

Ürün Kodu	Kısa Kod		Fiyat
AK.65.3524.P	Poşetli	34515 130	246.70
AK.65.3514.P	Kutu	26128 30	290.00
AK.65.3534.P	Blişter	34517 30	346.70



WC KAĞITLIK

Ürün Kodu	Kısa Kod		Fiyat
AK.67.3537.P	Poşetli	34518 100	140.00
AK.67.3507.P	Kutu	26130 40	176.70
AK.67.3557.P	Blişter	34520 40	206.70

- SS 430 kalite paslanmaz Rozet ve kapak
- Demir çubuk



SABUNLUK

Ürün Kodu	Kısa Kod		Fiyat
AK.63.3513.P	Poşetli	34521 100	156.70
AK.63.3503.P	Kutu	26126 30	193.40
AK.63.3523.P	Blişter	34523 30	223.40



ÇATAL BORNOZ ASKILIĞI

Ürün Kodu	Kısa Kod		Fiyat
AK.66.3537.P	Poşetli	34524 250	146.70
AK.66.3527.P	Kutu	26129 60	173.40
AK.66.3547.P	Blişter	34526 75	183.40



YUVARLAK HAVLULUK

Ürün Kodu	Kısa Kod		Fiyat
AK.64.3527.P	Poşetli	34527 100	163.40
AK.64.3517.P	Kutu	26127 40	200.00
AK.64.3537.P	Blişter	34529 25	273.40



WC KAPAKLI KAĞITLIK

Ürün Kodu	Kısa Kod		Fiyat
AK.68.3518.P	Poşetli	34530 80	190.00
AK.68.3508.P	Kutu	26131 40	226.70
AK.68.3528.P	Blişter	34532 30	263.40

- Krom kaplama
- Alüminyum gövde



ETAJER

Ürün Kodu	Kısa Kod		Fiyat
AK.61.3511.B	Poşetli	34533 75	303.40
AK.61.3501.B	Kutu	34534 20	360.00



DİŞ FIRÇALIK

Ürün Kodu	Kısa Kod		Fiyat
AK.62.3514.B	Poşetli	34536 100	156.70
AK.62.3504.B	Kutu	34537 30	193.40



UZUN HAVLULUK

Ürün Kodu	Kısa Kod		Fiyat
AK.65.3524.B	Poşetli	34539 130	246.70
AK.65.3514.B	Kutu	34540 30	290.00



WC KAĞITLIK

Ürün Kodu	Kısa Kod		Fiyat
AK.67.3537.B	Poşetli	34542 100	140.00
AK.67.3507.B	Kutu	34543 40	176.70

- SS 430 kalite paslanmaz Rozet ve kapak
- Demir çubuk



SABUNLUK

Ürün Kodu	Kısa Kod		Fiyat
AK.63.3513.B	Poşetli	34545 100	156.70
AK.63.3503.B	Kutu	34546 30	193.40



ÇATAL BORNOZ ASKILIĞI

Ürün Kodu	Kısa Kod		Fiyat
AK.66.3537.B	Poşetli	34548 250	146.70
AK.66.3527.B	Kutu	34549 60	173.40



YUVARLAK HAVLULUK

Ürün Kodu	Kısa Kod		Fiyat
AK.64.3527.B	Poşetli	34551 100	163.40
AK.64.3517.B	Kutu	34552 40	200.00



WC KAPAKLI KAĞITLIK

Ürün Kodu	Kısa Kod		Fiyat
AK.68.3518.B	Poşetli	34554 80	190.00
AK.68.3508.B	Kutu	34555 40	226.70

- Siyah mat kaplama
- Alüminyum gövde



KAĞIT HAVLULUK

Ürün Kodu	Kısa Kod		Fiyat
AK.67.3417.P	Poşetli	34557 80	156.70
AK.67.3407.P	Kutu	34558 30	203.40
AK.67.3427.P	Blister	34559 30	266.70



KAPAKLI KAĞIT HAVLULUK

Ürün Kodu	Kısa Kod		Fiyat
AK.67.3547.P	Poşetli	34560 70	210.00
AK.67.3527.P	Kutu	34561 30	256.70
AK.67.3557.P	Blister	34562 25	323.40



SEDEF BORNOZ ASKILIĞI

Ürün Kodu	Kısa Kod		Fiyat
AK.66.3538.P	Poşetli	34563 175	140.00
AK.66.3528.P	Kutu	34564 60	163.40
AK.66.3548.P	Blister	34565 50	183.40



V BORNOZ ASKILIĞI

Ürün Kodu	Kısa Kod		Fiyat
AK.66.3539.P	Poşetli	34566 250	146.70
AK.66.3529.P	Kutu	34567 60	173.40
AK.66.3549.P	Blister	34568 75	183.40



KAĞIT HAVLULUK

Ürün Kodu	Kısa Kod		Fiyat
AK.67.3417.B	Poşetli	34569 80	156.70
AK.67.3407.B	Kutu	34570 30	203.40



KAPAKLI KAĞIT HAVLULUK

Ürün Kodu	Kısa Kod		Fiyat
AK.67.3547.B	Poşetli	34572 70	210.00
AK.67.3527.B	Kutu	34573 30	256.70



SEDEF BORNOZ ASKILIĞI

Ürün Kodu	Kısa Kod		Fiyat
AK.66.3538.B	Poşetli	34575 175	140.00
AK.66.3528.B	Kutu	34576 60	163.40



V BORNOZ ASKILIĞI

Ürün Kodu	Kısa Kod		Fiyat
AK.66.3539.B	Poşetli	34578 250	146.70
AK.66.3529.B	Kutu	34579 60	173.40

New



2'Lİ MAKAS HAVLULK

Ürün Kodu	Kısa Kod		Fiyat
AK.20.5211.P	34581	12	1276.70

New



3'LÜ ASKILIK

Ürün Kodu	Kısa Kod		Fiyat
AK.20.9311.P	34582	12	430.00

New



5'Lİ ASKILIK

Ürün Kodu	Kısa Kod		Fiyat
AK.20.9511.P	34583	12	486.70



TEL SÜNGERLİK

Ürün Kodu	Kısa Kod		Fiyat
AK.75.1020.P	34584	20	640.00

New



3'LÜ MAKAS HAVLULK

Ürün Kodu	Kısa Kod		Fiyat
AK.20.5311.B	34585	12	1416.70

New



4'LÜ ASKILIK

Ürün Kodu	Kısa Kod		Fiyat
AK.20.9411.B	34586	12	463.40

New



6'Lİ ASKILIK

Ürün Kodu	Kısa Kod		Fiyat
AK.20.9611.B	34587	12	506.70



ROZETLİ TEL SÜNGERLİK

Ürün Kodu	Kısa Kod		Fiyat
AK.75.1120.B	34588	20	850.00



New

ETAJER

Ürün Kodu	Kısa Kod		Fiyat
AK.30.1011.P	34589	12	1430.00



New

SABUNLUK

Ürün Kodu	Kısa Kod		Fiyat
AK.30.2011.P	34594	12	853.40



New

DİŞ FIRÇALIK

Ürün Kodu	Kısa Kod		Fiyat
AK.30.3011.P	34590	12	853.40



New

BORNOZ ASKILIĞI

Ürün Kodu	Kısa Kod		Fiyat
AK.30.4011.P	34595	25	673.40



New

UZUN HAVLULUK 40 CM

Ürün Kodu	Kısa Kod		Fiyat
AK.30.5011.P	34591	12	1263.40



New

YUVARLAK HAVLULUK

Ürün Kodu	Kısa Kod		Fiyat
AK.30.6011.P	34597	12	950.00



New

WC KAĞITLIK

Ürün Kodu	Kısa Kod		Fiyat
AK.30.7011.P	34592	12	786.70



New

KAPAKLI WC KAĞITLIK

Ürün Kodu	Kısa Kod		Fiyat
AK.30.8011.P	34598	12	966.70

- Krom kaplama
- Prinç gövde

- SS 304 kalite paslanmaz kapak ve boru
- Kutu ambalaj



ETAJER

Ürün Kodu	Kısa Kod		Fiyat
AK.30.1011.E	34600	12	1523.40



DİŞ FIRÇALIK

Ürün Kodu	Kısa Kod		Fiyat
AK.30.3011.E	34601	12	1063.40



UZUN HAVLULUK 40 CM

Ürün Kodu	Kısa Kod		Fiyat
AK.30.5011.E	34602	12	1446.70



WC KAĞITLIK

Ürün Kodu	Kısa Kod		Fiyat
AK.30.7011.E	34603	12	876.70

- Antik kaplama
- Pirinç gövde



SABUNLUK

Ürün Kodu	Kısa Kod		Fiyat
AK.30.2011.E	34605	12	1063.40



BORNOZ ASKILIĞI

Ürün Kodu	Kısa Kod		Fiyat
AK.30.4011.E	34606	12	733.40



YUVARLAK HAVLULUK

Ürün Kodu	Kısa Kod		Fiyat
AK.30.6011.E	34608	12	1096.70



KAPAKLI WC KAĞITLIK

Ürün Kodu	Kısa Kod		Fiyat
AK.30.8011.E	34609	12	1163.40

- SS 304 kalite paslanmaz kapak ve boru
- Kutu ambalaj



New

ETAJER

Ürün Kodu	Kısa Kod		Fiyat
AK.30.1011.B	34611	12	1430.00



New

SABUNLUK

Ürün Kodu	Kısa Kod		Fiyat
AK.30.2011.B	34616	12	853.40



New

DİŞ FIRÇALIK

Ürün Kodu	Kısa Kod		Fiyat
AK.30.3011.B	34612	12	853.40



New

BORNOZ ASKILIĞI

Ürün Kodu	Kısa Kod		Fiyat
AK.30.4011.B	34617	25	673.40



New

UZUN HAVLULUK 40 CM

Ürün Kodu	Kısa Kod		Fiyat
AK.30.5011.B	34613	12	1263.40



New

YUVARLAK HAVLULUK

Ürün Kodu	Kısa Kod		Fiyat
AK.30.6011.B	34619	12	950.00



New

WC KAĞITLIK

Ürün Kodu	Kısa Kod		Fiyat
AK.30.7011.B	34614	12	786.70



New

KAPAKLI WC KAĞITLIK

Ürün Kodu	Kısa Kod		Fiyat
AK.30.8011.B	34621	12	966.70

- Siyah mat kaplama
- Prinç gövde

- SS 304 kalite paslanmaz kapak ve boru
- Kutu ambalaj

New



MARS SERİSİ 3'LÜ SET

Ürün Kodu	Kısa Kod		Fiyat
AK.60.0311.P	34623	8	690.00

New

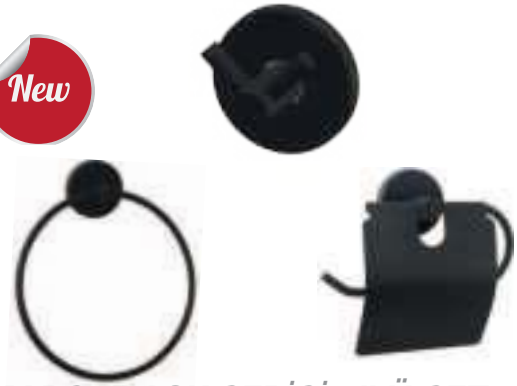

MARS BLACK SERİSİ 3'LÜ SET

Ürün Kodu	Kısa Kod		Fiyat
AK.60.0311.B	34626	8	690.00

New



ZÜMRÜT SERİSİ 3'LÜ SET

Ürün Kodu	Kısa Kod		Fiyat
AK.10.0311.P	34624	8	1853.40

New



ZÜMRÜT BLACK SERİSİ 3'LÜ SET

Ürün Kodu	Kısa Kod		Fiyat
AK.10.0311.B	34627	8	1853.40

New



KARE SERİSİ 3'LÜ SET

Ürün Kodu	Kısa Kod		Fiyat
AK.30.0311.P	34625	8	2390.00

New



KARE BLACK SERİSİ 3'LÜ SET

Ürün Kodu	Kısa Kod		Fiyat
AK.30.0311.B	34628	8	2390.00



KARE AYNA

Ürün Kodu	Kısa Kod		Fiyat
AK.91.4050.A	34629	40x50 cm 5	896.70



New

PRİZMA AYNA

Ürün Kodu	Kısa Kod		Fiyat
AK.91.4053.A	34632	40x50 cm 5	896.70



LAVİ AYNA

Ürün Kodu	Kısa Kod		Fiyat
AK.91.4051.A	34630	40x50 cm 5	896.70



New

BAĞDAT AYNA

Ürün Kodu	Kısa Kod		Fiyat
AK.91.4054.A	34633	40x50 cm 5	896.70



New

BAYRAK AYNA

Ürün Kodu	Kısa Kod		Fiyat
AK.91.4052.A	34631	40x50 cm 5	896.70



OVAL AYNA

Ürün Kodu	Kısa Kod		Fiyat
AK.91.4055.A	34634	40x50 cm 5	896.70



KARE AYNA

Ürün Kodu	Kısa Kod		Fiyat
AK.91.4060.A	34635	40x60 cm 5	1023.40
AK.91.5070.A	34610	50x70 cm 5	1310.00



New

PRİZMA AYNA

Ürün Kodu	Kısa Kod		Fiyat
AK.91.4063.A	34638	40x60 cm 5	1023.40



LAVİ AYNA

Ürün Kodu	Kısa Kod		Fiyat
AK.91.4061.A	34636	40x60 cm 5	1023.40



New

BAĞDAT AYNA

Ürün Kodu	Kısa Kod		Fiyat
AK.91.4064.A	34639	40x60 cm 5	1023.40

New



BAYRAK AYNA

Ürün Kodu	Kısa Kod		Fiyat
AK.91.4062.A	34637	40x60 cm 5	1023.40



OVAL AYNA

Ürün Kodu	Kısa Kod		Fiyat
AK.91.4065.A	34640	40x60 cm 5	1023.40



OKYANUS AYNA

Ürün Kodu	Kısa Kod		Fiyat
AK.92.5070.A	34641	50x70 cm 5	2383.40



EGE AYNA

Ürün Kodu	Kısa Kod		Fiyat
AK.92.5073.A	34644	50x70 cm 5	2383.40



KARADENİZ AYNA

Ürün Kodu	Kısa Kod		Fiyat
AK.92.5071.A	34642	50x70 cm 5	2383.40



MARMARA AYNA

Ürün Kodu	Kısa Kod		Fiyat
AK.92.5074.A	34645	50x70 cm 5	2383.40



AKDENİZ AYNA

Ürün Kodu	Kısa Kod		Fiyat
AK.92.5072.A	34643	50x70 cm 5	2383.40



GOLD EGE AYNA

Ürün Kodu	Kısa Kod		Fiyat
AK.92.5075.G	34646	50x70 cm 5	3893.40



DÜZ LEDLİ AYNA

Ürün Kodu	Kısa Kod		Fiyat
AK.90.8060.A	34647	80x60 cm 1	9006.70
AK.90.1060.A	34618	100x60 cm 1	11030.00



MAKYAJ AYNASI

Ürün Kodu	Kısa Kod		Fiyat
AK.90.8063.A	34652	40x60 cm 1	4140.00



MERCEKLİ LEDLİ AYNA

Ürün Kodu	Kısa Kod		Fiyat
AK.90.8061.A	34648	80x60 cm 1	10896.70
AK.90.1061.A	34649	100x60 cm 1	12920.00



LEDLİ MAKYAJ AYNASI

Ürün Kodu	Kısa Kod		Fiyat
AK.90.8064.A	34653	40x60 cm 1	7253.40



DESENLİ LEDLİ AYNA

Ürün Kodu	Kısa Kod		Fiyat
AK.90.8062.A	34650	80x60 cm 1	9006.70
AK.90.1062.A	34651	100x60 cm 1	11030.00



TEKLİ KÖŞE SÜNGERLİK

Ürün Kodu	Kısa Kod		Fiyat
AK.74.1018.K	34654	18x18 cm 24	673.40



TEKLİ OVAL SÜNGERLİK

Ürün Kodu	Kısa Kod		Fiyat
AK.74.1020.K	34657	19x19 cm 24	733.40

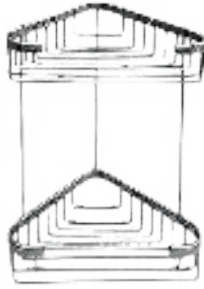

İKİLİ KÖŞE SÜNGERLİK

Ürün Kodu	Kısa Kod		Fiyat
AK.74.2018.K	34655	18x18 cm 16	1323.40



İKİLİ OVAL SÜNGERLİK

Ürün Kodu	Kısa Kod		Fiyat
AK.74.2020.K	34620	19x19 cm 16	1456.70



ÜÇLÜ KÖŞE SÜNGERLİK

Ürün Kodu	Kısa Kod		Fiyat
AK.74.3018.K	34656	18x18 cm 12	1940.00

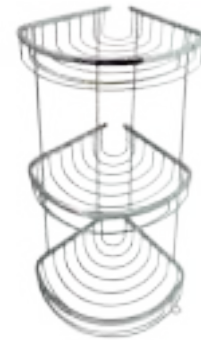

ÜÇLÜ OVAL SÜNGERLİK

Ürün Kodu	Kısa Kod		Fiyat
AK.74.3020.K	34615	19x19 cm 12	2143.40



TEKLİ KÖŞE SÜNGERLİK

Ürün Kodu	Kısa Kod	Boyut	Adet	Fiyat
AK.80.1018.K	13509	18x18 cm	24	993.40



TEKLİ OVAL SÜNGERLİK

Ürün Kodu	Kısa Kod	Boyut	Adet	Fiyat
AK.80.1020.K	13510	19x19 cm	24	1143.40

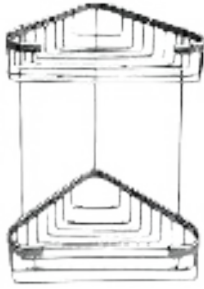

İKİLİ KÖŞE SÜNGERLİK

Ürün Kodu	Kısa Kod	Boyut	Adet	Fiyat
AK.80.2018.K	13512	18x18 cm	16	1806.70



İKİLİ OVAL SÜNGERLİK

Ürün Kodu	Kısa Kod	Boyut	Adet	Fiyat
AK.80.2020.K	13513	19x19 cm	16	2490.00



ÜÇLÜ KÖŞE SÜNGERLİK

Ürün Kodu	Kısa Kod	Boyut	Adet	Fiyat
AK.80.3018.K	13516	18x18 cm	12	2670.00

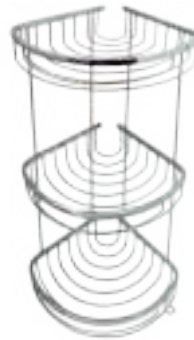

ÜÇLÜ OVAL SÜNGERLİK

Ürün Kodu	Kısa Kod	Boyut	Adet	Fiyat
AK.80.3020.K	13515	19x19 cm	12	3210.00

OTOMATİK PLASTİK

Ürün Kodu	Kısa Kod	Yüzey	Ölçü	Fiyat
HD.01.4923.SM	13376	Şeffaf Mavi	27x22x36 cm	4463.40



OTOMATİK PLASTİK BEYAZ

Ürün Kodu	Kısa Kod	Yüzey	Ölçü	Fiyat
HD.01.4923.SB	26359	Beyaz	27x22x36 cm	4463.40



PLASTİK MASA ÜSTÜ MİNİ PEÇETELİK

Ürün Kodu	Kısa Kod	Yüzey	Ölçü	Fiyat
HD.23.1014.KR	34658	Krom	10x14x3 cm	376.70



PLASTİK MASA ÜSTÜ MAXİ PEÇETELİK

Ürün Kodu	Kısa Kod	Yüzey	Ölçü	Fiyat
HD.23.1324.KR	34659	Krom	24x13x6 cm	553.40



PLASTİK MASA ÜSTÜ BOX PEÇETELİK

Ürün Kodu	Kısa Kod	Yüzey	Ölçü	Fiyat
HD.23.1313.KR	34660	Krom	13x13x13 cm	916.70





PLASTİK KÖPÜK VERİCİ

Ürün Kodu	Kısa Kod	Yüzey	Ölçü	Fiyat
HD.44.4715.SY	30954	Siyah	11x21x12 cm	636.70



SIVI SABUNLUK

Ürün Kodu	Kısa Kod	Yüzey	Kapasite	Fiyat
HD.35.4716.SM	13434	Şeffaf Mavi	500 ml	166.70
HD.37.4716.SM	13435	Şeffaf Mavi	1000 ml	270.00



PLASTİK KÖPÜK VERİCİ

Ürün Kodu	Kısa Kod	Yüzey	Ölçü	Fiyat
HD.45.5012.SM	34661	500 ml Şeffaf	8x11x15 cm	353.40
HD.45.9012.SM	34662	900 ml Şeffaf	10x14x19 cm	460.00



600 ML. SABUN VE ŞAMPUAN VERİCİ

Ürün Kodu	Kısa Kod	Yüzey	Ölçü	Fiyat
HD.46.6010.BM	34663	Beyaz	8x11x15 cm	680.00
HD.46.6010.KM	34664	Krom	10x14x19 cm	930.00



1100 ML. SABUN VE ŞAMPUAN VERİCİ

Ürün Kodu	Kısa Kod	Yüzey	Ölçü	Fiyat
HD.46.1110.BM	34665	Beyaz	8x11x15 cm	823.40
HD.46.1110.KM	34666	Krom	10x14x19 cm	1036.70

170 ML. SABUN VE ŞAMPUAN VERİCİ

Ürün Kodu	Kısa Kod	Yüzey	Ölçü	Fiyat
HD.46.1710.BM	34667	Beyaz	8x11x15 cm	533.40
HD.46.1710.KM	34668	Krom	10x14x19 cm	733.40



170 ML. SABUN VE ŞAMPUAN VERİCİ

Ürün Kodu	Kısa Kod	Yüzey	Ölçü	Fiyat
HD.47.1710.BM	34669	500 ml Şeffaf	8x11x15 cm	576.70
HD.47.1710.KM	34670	900 ml Şeffaf	10x14x19 cm	793.40



170 ML. SABUN VE ŞAMPUAN VERİCİ

Ürün Kodu	Kısa Kod	Yüzey	Ölçü	Fiyat
HD.47.1720.BM	34671	Beyaz	8x11x15 cm	1040.00
HD.47.1720.KM	34672	Krom	10x14x19 cm	1453.40



250 ML. SABUN VE ŞAMPUAN VERİCİ

Ürün Kodu	Kısa Kod	Yüzey	Ölçü	Fiyat
HD.47.1730.BM	34673	Beyaz	8x11x15 cm	1536.70
HD.47.1730.KM	34674	Krom	10x14x19 cm	2060.00





250 ML. SABUN VE ŞAMPUAN VERİCİ

Ürün Kodu	Kısa Kod	Yüzey	Ölçü	İkili	Fiyat
HD.46.2510.BM	34675	Beyaz	8x11x15 cm	12	576.70
HD.46.2510.KM	34676	Krom	10x14x19 cm	12	766.70



250 ML. SABUN VE ŞAMPUAN VERİCİ

Ürün Kodu	Kısa Kod	Yüzey	Ölçü	İkili	Fiyat
HD.47.2510.BM	34677	Beyaz	8x11x15 cm	12	650.00
HD.47.2510.KM	34678	Krom	10x14x19 cm	12	826.70



250 ML. SABUN VE ŞAMPUAN VERİCİ

Ürün Kodu	Kısa Kod	Yüzey	Ölçü	İkili	Fiyat
HD.47.2520.BM	34679	Beyaz	8x11x15 cm	12	1170.00
HD.47.2520.KM	34680	Krom	10x14x19 cm	12	1530.00



250 ML. SABUN VE ŞAMPUAN VERİCİ

Ürün Kodu	Kısa Kod	Yüzey	Ölçü	İkili	Fiyat
HD.47.2530.BM	34681	Beyaz	8x11x15 cm	12	1516.70
HD.47.2530.KM	34682	Krom	10x14x19 cm	12	2083.40

Z KATLI DİSPANSER 200'LÜK

Ürün Kodu	Kısa Kod	Yüzey	Ölçü	İkili	Fiyat
HD.03.4923.SM	13378	Şeffaf Mavi	23x21x9 cm	20	346.70



Z KATLI DİSPANSER 300'LÜK

Ürün Kodu	Kısa Kod	Yüzey	Ölçü	İkili	Fiyat
HD.02.4923.SM	30960	Şeffaf Mavi	26x29x11 cm	20	486.70
HD.02.4923.SY	30958	Siyah	26x29x11 cm	20	696.70



JUMBO Z KATLI DİSPANSER 300'LÜK

Ürün Kodu	Kısa Kod	Yüzey	Ölçü	İkili	Fiyat
HD.20.3029.SM	34683	Şeffaf Mavi	23x21x9 cm	6	880.00



Z KATLI DİSPANSER 400'LÜK

Ürün Kodu	Kısa Kod	Yüzey	Ölçü	İkili	Fiyat
HD.21.3028.SM	34684	Şeffaf Mavi	28x38x10 cm	6	990.00



KİLİTLİ Z KATLI DİSPANSER 250'LİK

Ürün Kodu	Kısa Kod	Yüzey	Ölçü	İkili	Fiyat
HD.23.3025.SM	34685	Şeffaf Mavi	29x30x13 cm	6	593.40





• Şeffaf manuel

JUMBO TUVALET KAĞIDI VERİCİ

Ürün Kodu	Kısa Kod	Yüzey	Ölçü	Fiyat
HD.06.4923.SM	30972	Şeffaf Mavi	Ø24x26 cm 20	470.00
HD.06.4923.SY	30970	Siyah	Ø24x26 cm 20	660.00

CİMRİ KAĞIT VERİCİ

Ürün Kodu	Kısa Kod	Yüzey	Ölçü	Fiyat
HD.08.4923.SM	30981	Şeffaf Mavi	Ø20 cm 20	436.70
HD.07.4923.SM	30978	Şeffaf Mavi	Ø25 cm 12	690.00
HD.07.4923.SY	30976	Siyah	Ø25 cm 12	820.00



KİLİTLİ MİNİ JUMBO KAĞIT VERİCİ

Ürün Kodu	Kısa Kod	Yüzey	Ölçü	Fiyat
HD.25.2522.SM	34686	Şeffaf Mavi	22x25x12 cm 6	790.00



MİNİ JUMBO KAĞIT VERİCİ

Ürün Kodu	Kısa Kod	Yüzey	Ölçü	Fiyat
HD.04.4923.SM	30966	Şeffaf Mavi	Ø21x24 cm 24	393.40



